



PROMOTIONAL PRODUCTS CATALOGUE

Design & Production



european manufacturer
SINCE 1951

TABLE OF CONTENTS

<i>Paper Pen with Lid</i> 6 	<i>Paper Pen Retractable</i> 8 	<i>Eco Pen</i> 10 	<i>Focus</i> 68 	<i>Videotip</i> 72 	<i>Videotip XXL</i> 76 
<i>Nova</i> 14 	<i>Starlet</i> 18 	<i>Star</i> 22 	<i>Videotip Slim</i> 78 	<i>Whiteboard Marker M</i> 82 	<i>Whiteboard Marker</i> 84 
<i>Olimpia 007</i> 28 	<i>Fresh 007</i> 32 	<i>Alfa 007</i> 34 	<i>Whiteboard Marker XXL</i> 86 	<i>Whiteboard Marker Multifunctional</i> 88 	<i>Permanent Marker F</i> 90 
<i>Buggy 007</i> 38 	<i>Sunny</i> 42 	<i>X-pen</i> 46 	<i>Permanent Marker M</i> 92 	<i>Permanent Marker XXL</i> 94 	<i>ICO 300</i> 96 
<i>Orion</i> 48 	<i>Silver</i> 50 	<i>ICO 70</i> 54 	<i>Brush Pen</i> 98 	<i>T-Shirt Marker</i> 100 	<i>T-Shirt Marker XXL</i> 102 
<i>Apollo</i> 58 	<i>Polo</i> 62 	<i>Mix n' Match</i> 64 	<i>Counter Pens</i> 106 	<i>Desk Accessories</i> 112 	

BALLPENS

PAPER PEN

WITH LID

Available Colours:

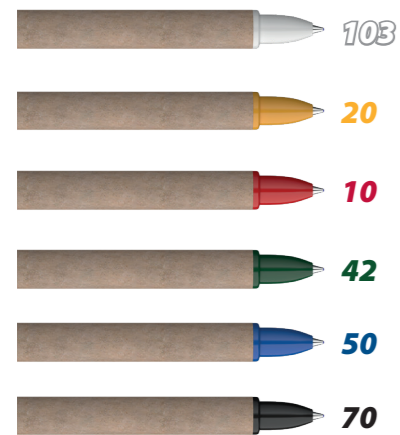

BRANDING POSSIBILITIES

SCREEN PRINTING

BARREL



360° PRINTING

BARREL



SPECIFICATIONS

Ballpen made of recycled paper and reused plastic parts.

Ø: 11,2 mm

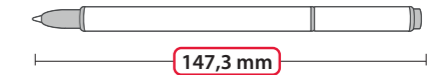

Product size: 147,3 mm
Diameter: 11,2 mm

Refill: X-20
ball diameter: 0,8 mm
length: 106,8 mm
writing capacity: 2500 m
available colours:

PACKAGING



- Box dimensions: W 40 cm x L 40 cm x H 27 cm
- Weight: 9 kg
- Number of pieces packed: 1000 pcs
- Unit: 200 pcs/polybag

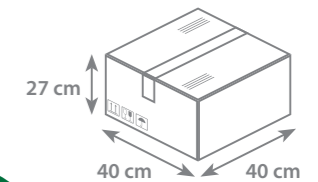

RECYCLED PLASTIC 30% | RECYCLED PAPER 100%



PAPER PEN

RETRACTABLE



Available Colours:

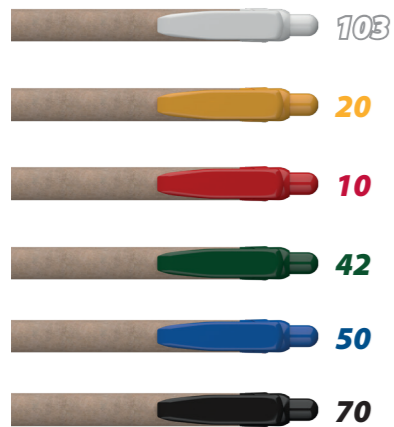

BRANDING POSSIBILITIES

PAD PRINTING

CLIP

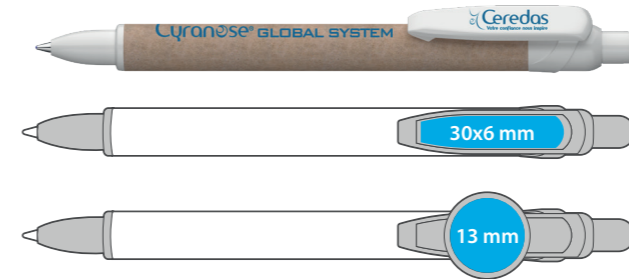

SCREEN PRINTING

BARREL

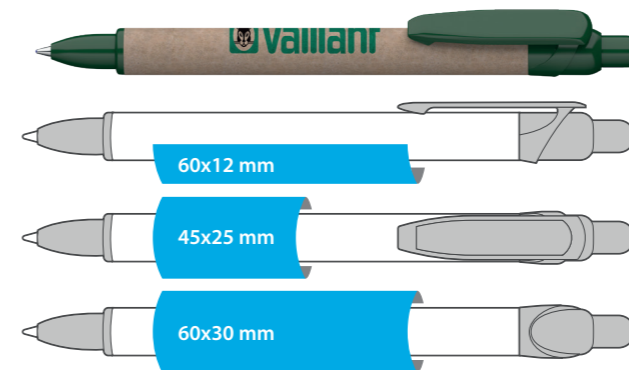

360° PRINTING

BARREL

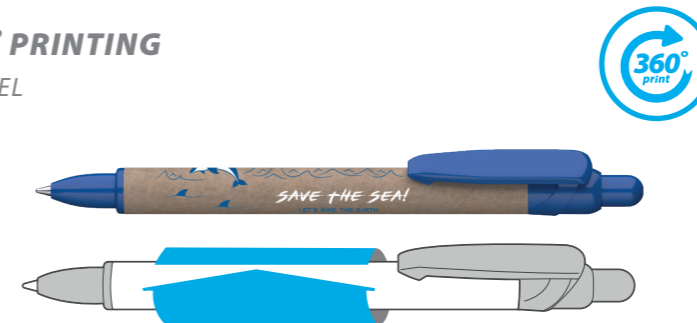

SPECIFICATIONS

Retractable paper pen made of recycled paper and reused plastic parts.

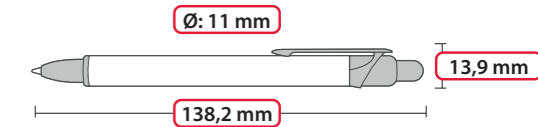

Product size: **138,2 mm x 13,9 mm**
Diameter: **11 mm**

Refill: **X-20**
ball diameter: **0,8 mm**
length: **106,8 mm**
writing capacity: **2500 m**
available colours:

PACKAGING



- Box dimensions: W 40 cm x L 40 cm x H 27 cm
- Weight: 10 kg
- Number of pieces packed: 1000 pcs
- Unit: 200 pcs/polybag

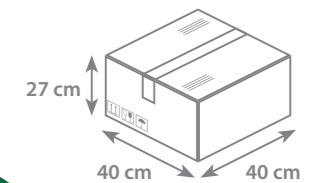

RECYCLED PLASTIC

30%

RECYCLED PAPER

100%



ECO PEN

STANDARD

Available Colours:

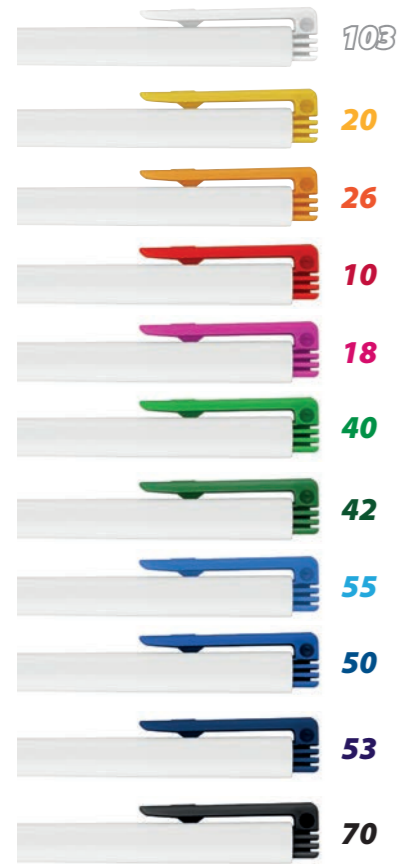

BRANDING POSSIBILITIES

SCREEN PRINTING

BARREL



360° PRINTING

BARREL



SPECIFICATIONS

Economy ballpoint pen assembled with replaceable X-20 refill.

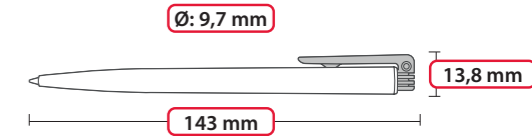

Product size: 143 mm x 13,8 mm
Diameter: 9,7 mm

Refill: X-20
ball diameter: 0,8 mm
length: 106,8 mm
writing capacity: 2500 m
available colours:

PACKAGING



- Box dimensions: W 34 cm x L 34 cm x H 18 cm
- Weight: 6 kg
- Number of pieces packed: 1000 pcs
- Unit: 200 pcs/polybag

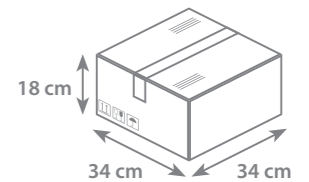

For further information go to Page 65.

ECO PEN

COLOUR



Available Colours:



BRANDING POSSIBILITIES

SCREEN PRINTING

BARREL

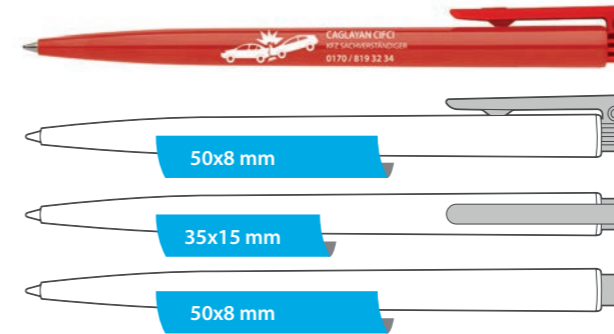

360° PRINTING

BARREL



SPECIFICATIONS

Economy ballpoint pen assembled with replaceable X-20 refill.

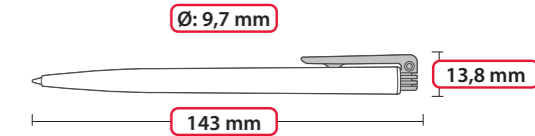

Product size: 143 mm x 13,8 mm
Diameter: 9,7 mm

Refill: X-20
ball diameter: 0,8 mm
length: 106,8 mm
writing capacity: 2500 m
available colours:

PACKAGING



- Box dimensions: W 34 cm x L 34 cm x H 18 cm
- Weight: 6 kg
- Number of pieces packed: 1000 pcs
- Unit: 200 pcs/polybag

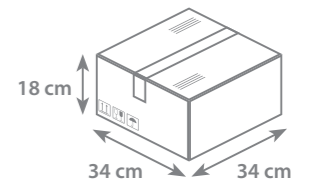

For further information go to Page 65.

NOVA

STANDARD

Available Colours:

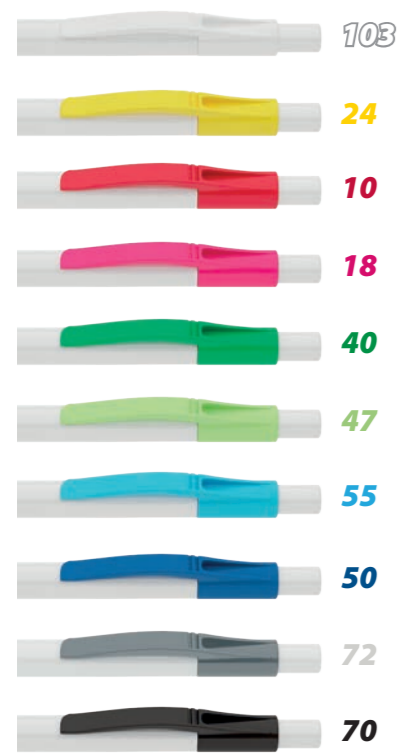

BRANDING POSSIBILITIES

PAD PRINTING

CLIP



SCREEN PRINTING

BARREL

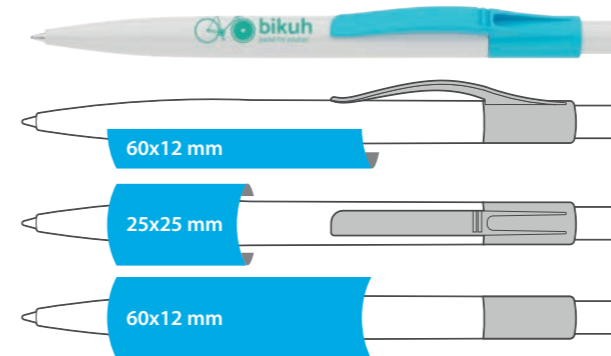

360° PRINTING

BARREL



SPECIFICATIONS

New model with large print area assembled with replaceable X-20 refill.

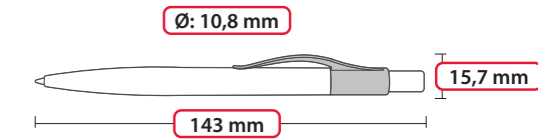

Product size: **143 mm x 15,7 mm**
Diameter: **10,8 mm**

Refill: **X-20**
ball diameter: **0,8 mm**
length: **106,8 mm**
writing capacity: **2500 m**
available colours:

PACKAGING



- Box dimensions: W 40 cm x L 40 cm x H 27 cm
- Weight: 8 kg
- Number of pieces packed: 1000 pcs
- Unit: 200 pcs/polybag

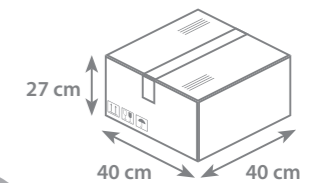

For further information go to Page 65.

NOVA

COLOUR

Available Colours:

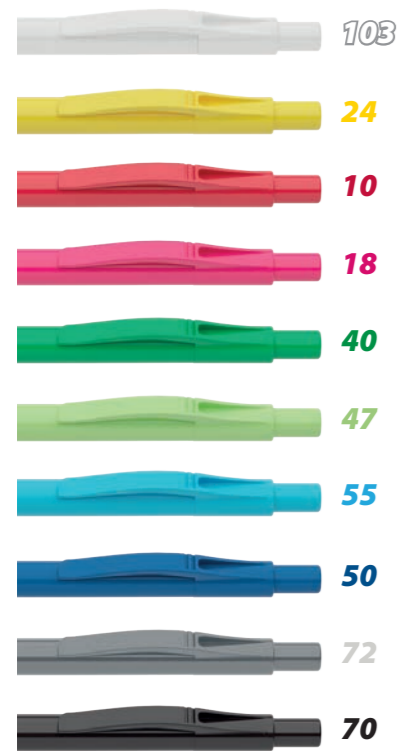

BRANDING POSSIBILITIES

PAD PRINTING

CLIP



SCREEN PRINTING

BARREL

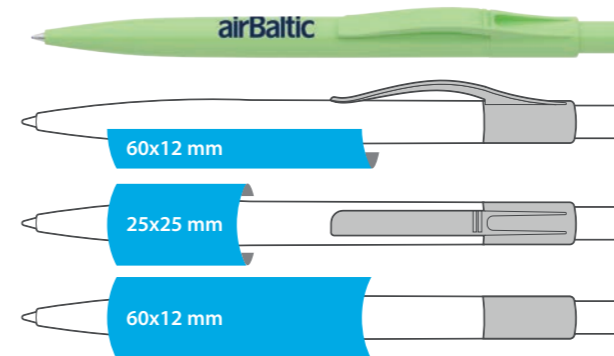

360° PRINTING

BARREL



SPECIFICATIONS

New model with large print area assembled with replaceable X-20 refill.

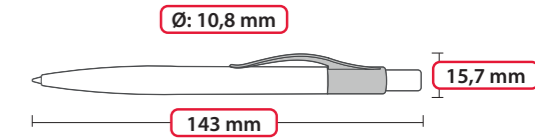

Product size: 143 mm x 15,7 mm
Diameter: 10,8 mm

Refill: X-20
ball diameter: 0,8 mm
length: 106,8 mm
writing capacity: 2500 m
available colours:

PACKAGING



- Box dimensions: W 40 cm x L 40 cm x H 27 cm
- Weight: 8 kg
- Number of pieces packed: 1000 pcs
- Unit: 200 pcs/polybag

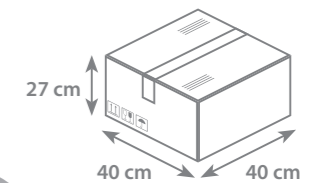

For further information go to Page 65.



STARLET

STANDARD

Available Colours:

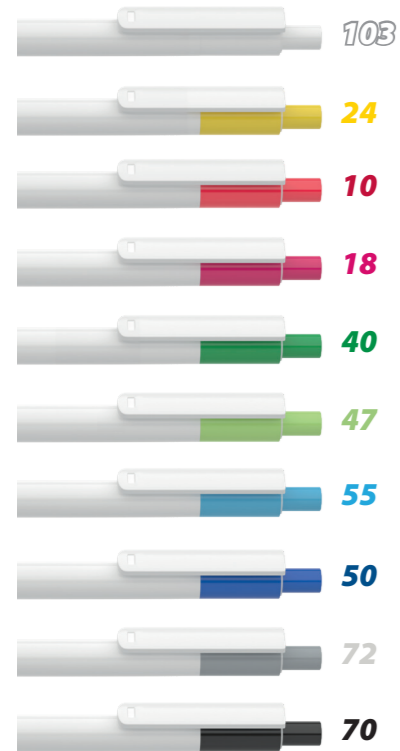

BRANDING POSSIBILITIES

PAD PRINTING

CLIP

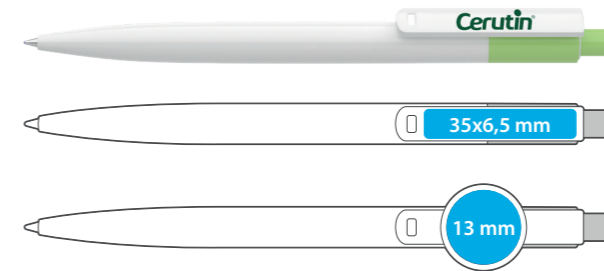

SCREEN PRINTING

BARREL

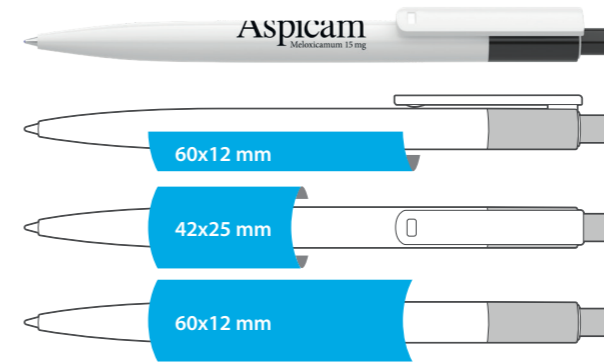

360° PRINTING

BARREL



SPECIFICATIONS

New model with large print area on both clip and barrel.

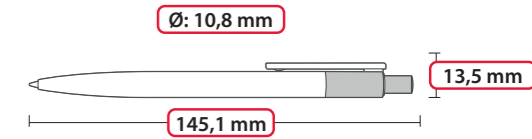

Product size: **145,1 mm x 13,5 mm**
Diameter: **10,8 mm**

Refill: **X-20**
ball diameter: **0,8 mm**
length: **106,8 mm**
writing capacity: **2500 m**
available colours:

PACKAGING



- Box dimensions: W 40 cm x L 40 cm x H 27 cm
- Weight: 8 kg
- Number of pieces packed: 1000 pcs
- Unit: 200 pcs/polybag

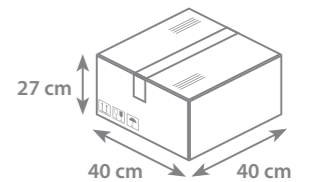

For further information go to Page 65.



STARLET

COLOUR

Available Colours:

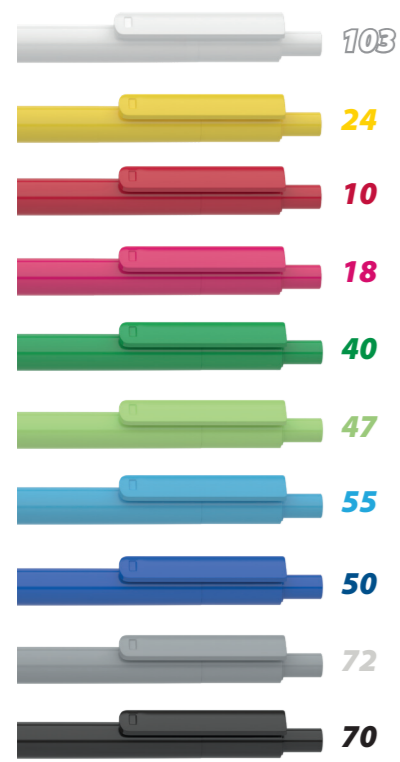

BRANDING POSSIBILITIES

PAD PRINTING

CLIP

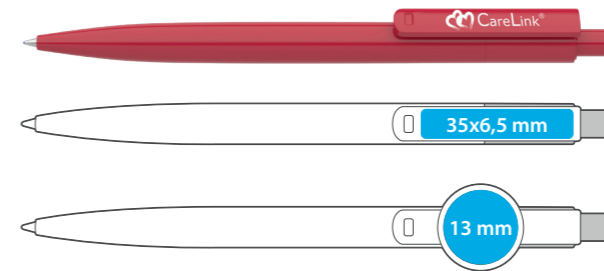

SCREEN PRINTING

BARREL

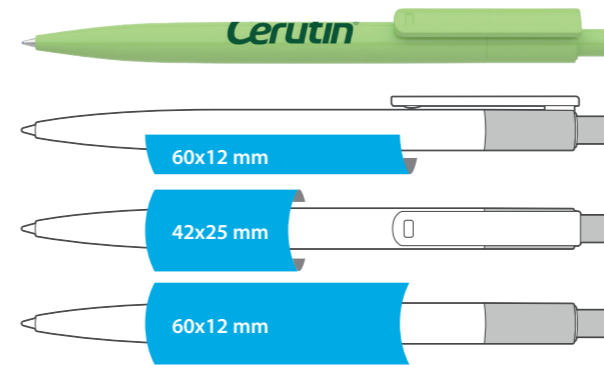

360° PRINTING

BARREL



SPECIFICATIONS

New model with large print area on both clip and barrel.

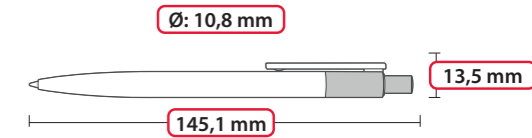

Product size: **145,1 mm x 13,5 mm**
Diameter: **10,8 mm**

Refill: **X-20**
ball diameter: **0,8 mm**
length: **106,8 mm**
writing capacity: **2500 m**
available colours:

PACKAGING



- Box dimensions: W 40 cm x L 40 cm x H 27 cm
- Weight: 8 kg
- Number of pieces packed: 1000 pcs
- Unit: 200 pcs/polybag

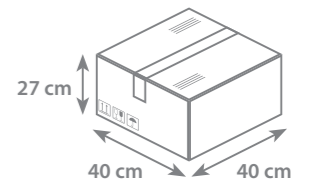

For further information go to Page 65.

STAR

STANDARD

Available Colours:

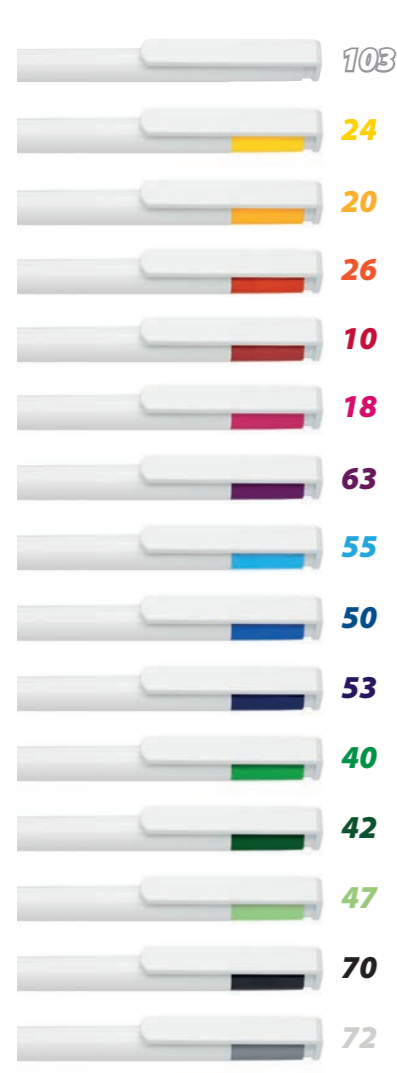

BRANDING POSSIBILITIES

PAD PRINTING

CLIP



SCREEN PRINTING

BARREL

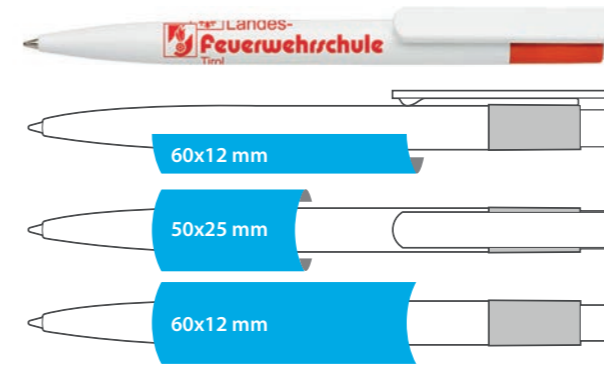

360° PRINTING

BARREL

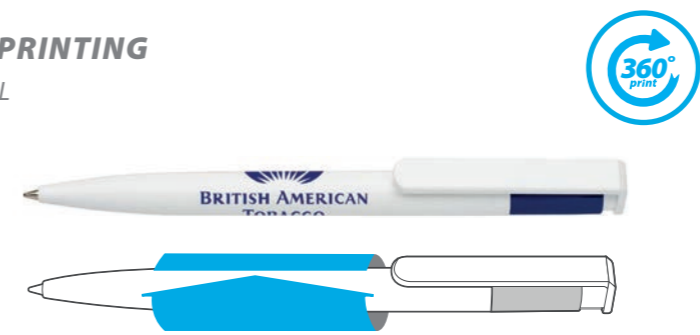

SPECIFICATIONS

One of our most popular models with excellent print areas.

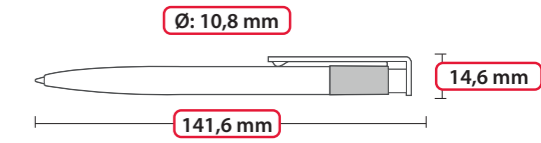

Product size: 141,6 mm x 14,6 mm
Diameter: 10,8 mm

Refill: X-20
ball diameter: 0,8 mm
length: 106,8 mm
writing capacity: 2500 m
available colours:

PACKAGING



- Box dimensions: W 40 cm x L 40 cm x H 27 cm
- Weight: 8 kg
- Number of pieces packed: 1000 pcs
- Unit: 200 pcs/polybag

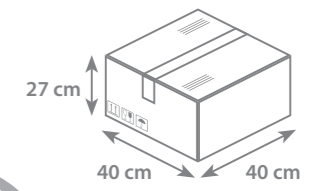

For further information go to Page 65.



STAR COLOUR

Available Colours:

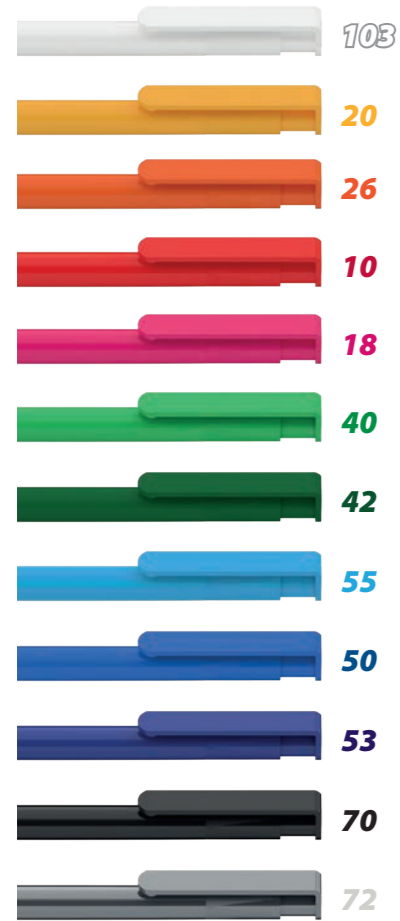

BRANDING POSSIBILITIES

PAD PRINTING

CLIP

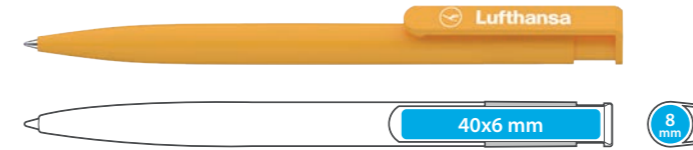

SCREEN PRINTING

BARREL

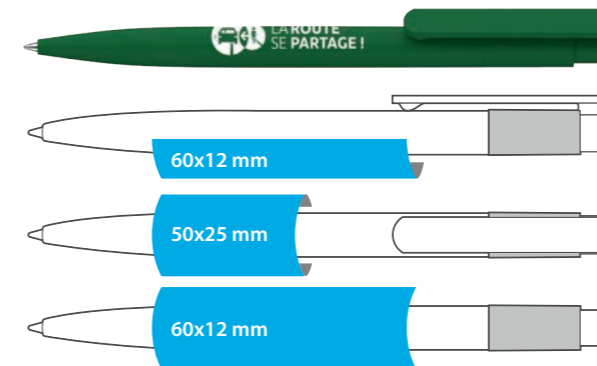

360° PRINTING

BARREL



SPECIFICATIONS

One of our most popular models with excellent print areas in solid colours.

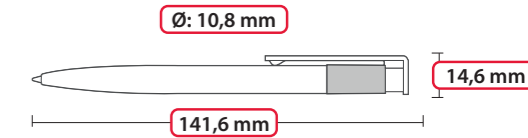

Product size: **141,6 mm x 14,6 mm**
Diameter: **10,8 mm**

Refill: **X-20**
ball diameter: **0,8 mm**
length: **106,8 mm**
writing capacity: **2500 m**
available colours:

PACKAGING



- Box dimensions: W 40 cm x L 40 cm x H 27 cm
- Weight: 8 kg
- Number of pieces packed: 1000 pcs
- Unit: 200 pcs/polybag

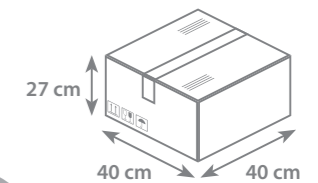

For further information go to Page 65.

STAR

TRANSLUCENT



Available Colours:

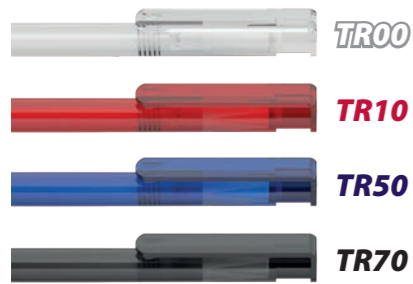

BRANDING POSSIBILITIES

PAD PRINTING

CLIP

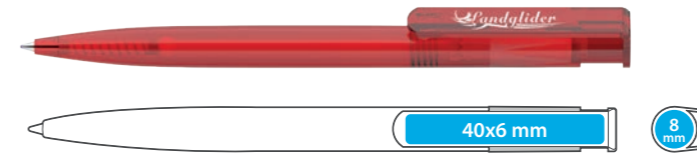

SCREEN PRINTING

BARREL

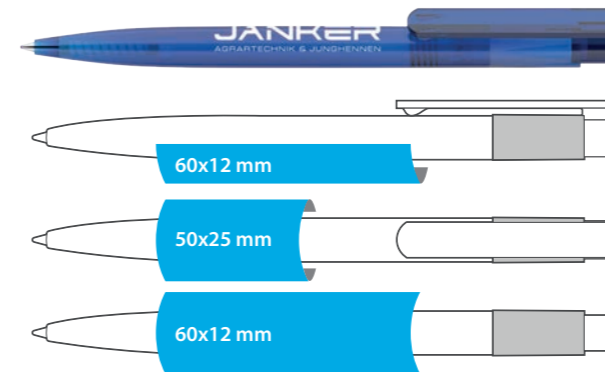

360° PRINTING

BARREL



SPECIFICATIONS

One of our most popular models in translucent colours with excellent print areas.

Ø: 10,8 mm

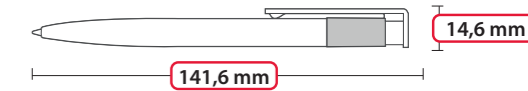

Product size: 141,6 mm x 14,6 mm
Diameter: 10,8 mm

Refill: X-20
ball diameter: 0,8 mm
length: 106,8 mm
writing capacity: 2500 m
available colours:

PACKAGING



- Box dimensions: W 40 cm x L 40 cm x H 27 cm
- Weight: 8 kg
- Number of pieces packed: 1000 pcs
- Unit: 200 pcs/polybag

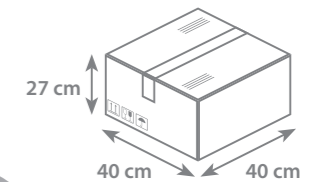

For further information go to Page 65.



OLIMPIA 007

STANDARD

Available Colours:

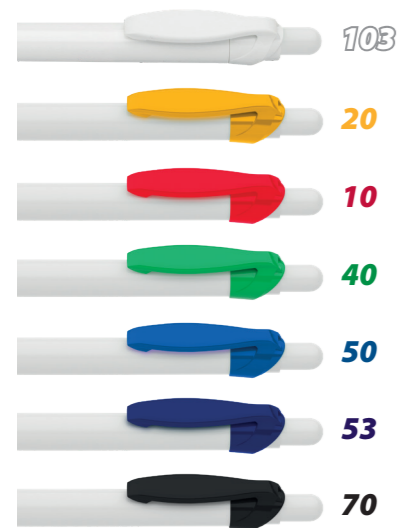

BRANDING POSSIBILITIES

PAD PRINTING

CLIP

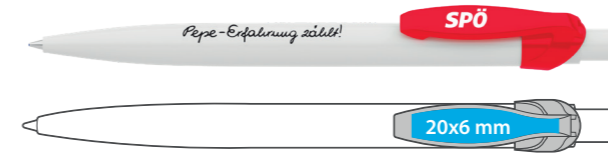

SCREEN PRINTING

BARREL

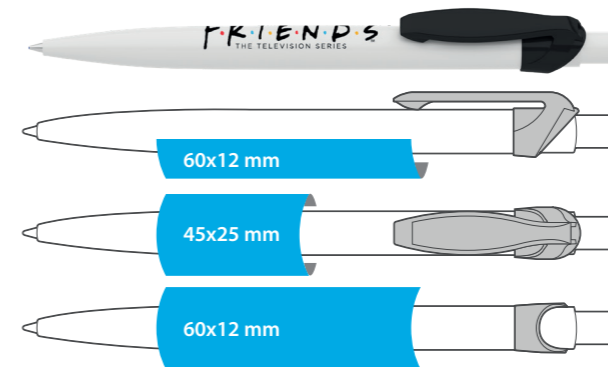

360° PRINTING

BARREL

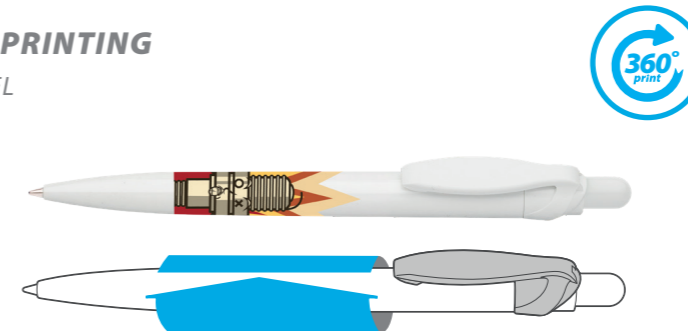

SPECIFICATIONS

Retractable ballpoint pen, replaceable X-20 refill and coloured clip.

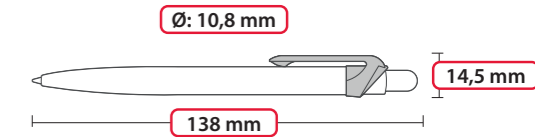

Product size: **138 mm x 14,5 mm**
Diameter: **10,8 mm**

Refill: **X-20**
ball diameter: **0,8 mm**
length: **106,8 mm**
writing capacity: **2500 m**
available colours:

PACKAGING



- Box dimensions: W 40 cm x L 40 cm x H 27 cm
- Weight: 8 kg
- Number of pieces packed: 1000 pcs
- Unit: 200 pcs/polybag

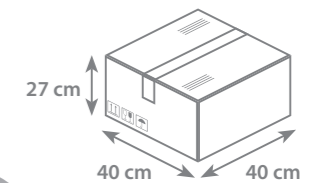

For further information go to Page 65.

OLIMPIA 007

COLOUR



Available Colours:

- 103
- 20
- 10
- 40
- 50
- 53
- 70

BRANDING POSSIBILITIES

PAD PRINTING

CLIP

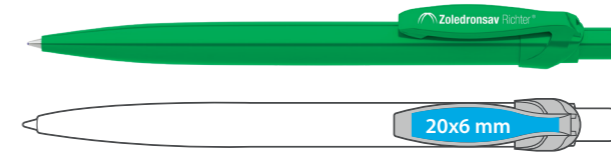

SCREEN PRINTING

BARREL

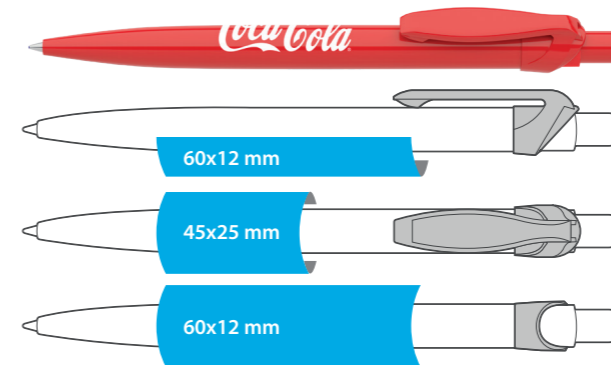

360° PRINTING

BARREL

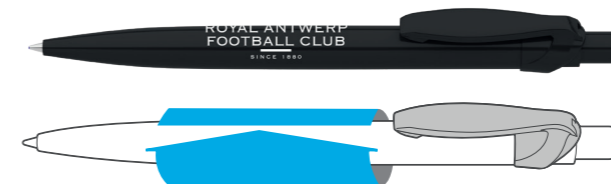

SPECIFICATIONS

Retractable ballpoint pen, replaceable X-20 refill and coloured clip and barrel.

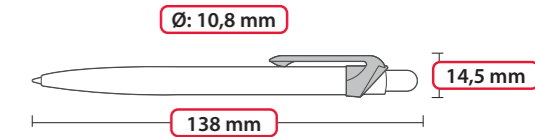

Product size: **138 mm x 14,5 mm**
Diameter: **10,8 mm**

Refill: **X-20**
ball diameter: **0,8 mm**
length: **106,8 mm**
writing capacity: **2500 m**
available colours:

PACKAGING



- Box dimensions: W 40 cm x L 40 cm x H 27 cm
- Weight: 8 kg
- Number of pieces packed: 1000 pcs
- Unit: 200 pcs/polybag

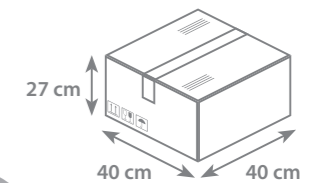

For further information go to Page 65.



FRESH 007

TRANSLUCENT



Available Colours:



BRANDING POSSIBILITIES

PAD PRINTING

CLIP

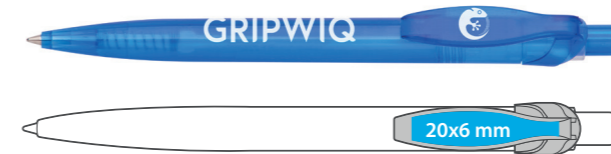

SCREEN PRINTING

BARREL

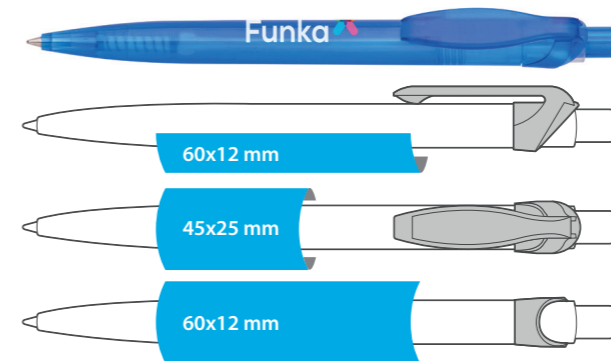

360° PRINTING

BARREL

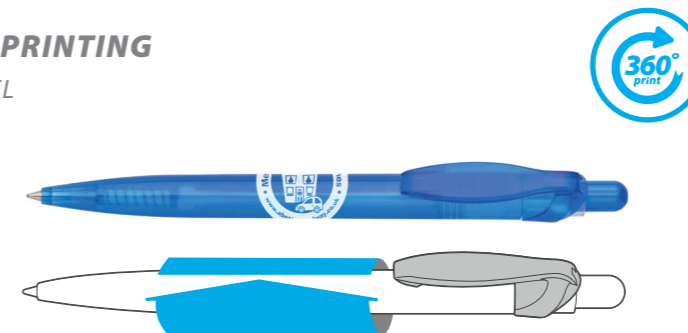

SPECIFICATIONS

Retractable ballpoint pen, replaceable X-20 refill and translucent clip and barrel.

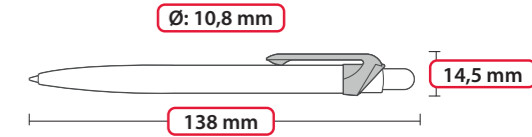

Product size: **138 mm x 14,5 mm**
Diameter: **10,8 mm**

Refill: **X-20**
ball diameter: **0,8 mm**
length: **106,8 mm**
writing capacity: **2500 m**
available colours:

PACKAGING



- Box dimensions:
W 40 cm x L 40 cm x H 27 cm
- Weight: 8 kg
- Number of pieces packed: 1000 pcs
- Unit: 200 pcs/polybag

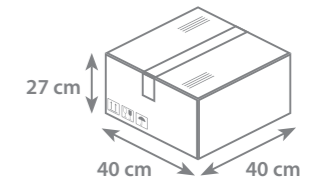

ALFA 007

STANDARD

Available Colours:

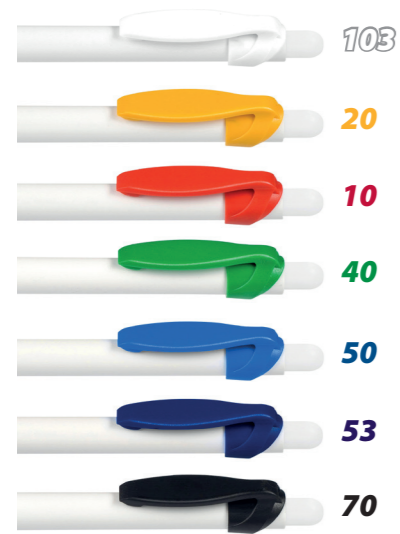

BRANDING POSSIBILITIES

PAD PRINTING

CLIP

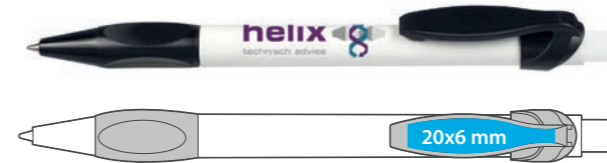

SCREEN PRINTING

BARREL

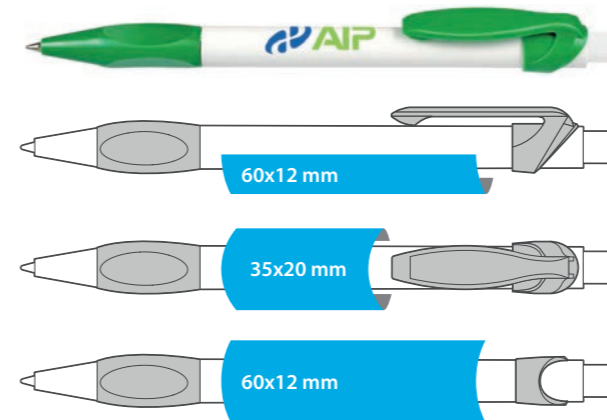

360° PRINTING

BARREL

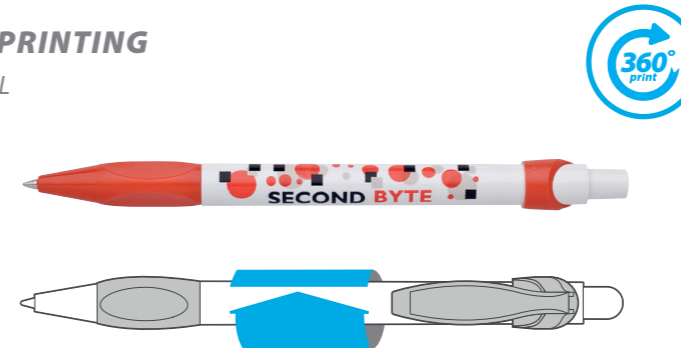

SPECIFICATIONS

A ballpen with an ergonomic, colourful grip zone and replaceable X-20 refill.

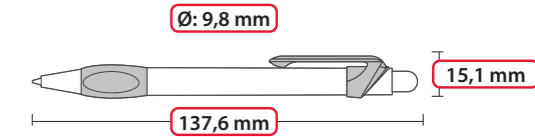

Product size: **137,6 mm x 15,1 mm**
Diameter: **9,8 mm**

Refill: **X-20**
ball diameter: **0,8 mm**
length: **106,8 mm**
writing capacity: **2500 m**
available colours:

PACKAGING



- Box dimensions: W 40 cm x L 40 cm x H 27 cm
- Weight: 8 kg
- Number of pieces packed: 1000 pcs
- Unit: 200 pcs/polybag

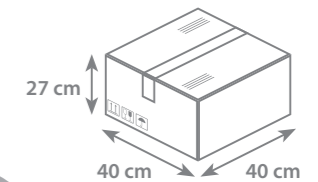

For further information go to Page 65.

ALFA 007

COLOUR

Available Colours:

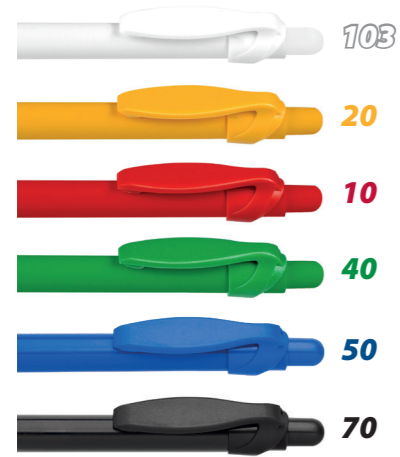

BRANDING POSSIBILITIES

PAD PRINTING

CLIP

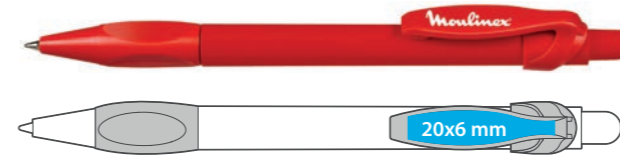

SCREEN PRINTING

BARREL

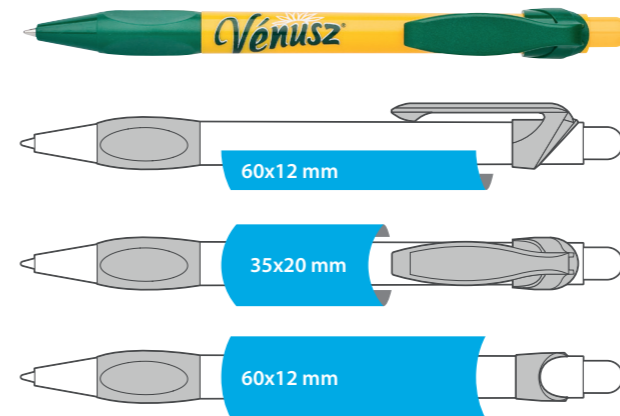

360° PRINTING

BARREL

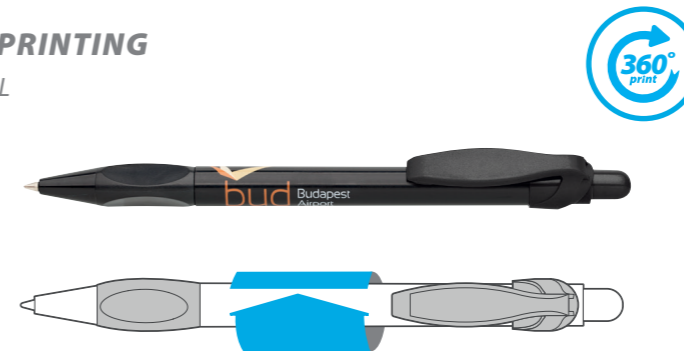

SPECIFICATIONS

Solid colour ballpen with an ergonomic grip zone and replaceable X-20 refill.

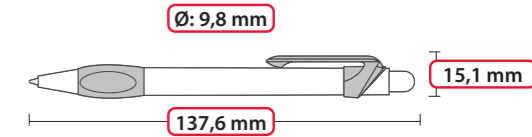

Product size: 137,6 mm x 15,1 mm
Diameter: 9,8 mm

Refill: X-20
ball diameter: 0,8 mm
length: 106,8 mm
writing capacity: 2500 m
available colours:

PACKAGING



- Box dimensions: W 40 cm x L 40 cm x H 27 cm
- Weight: 8 kg
- Number of pieces packed: 1000 pcs
- Unit: 200 pcs/polybag

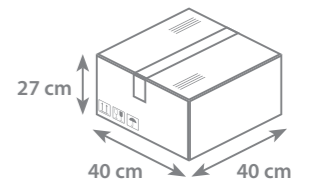

For further information go to Page 65.

BUGGY 007

STANDARD



BRANDING POSSIBILITIES

PAD PRINTING

CLIP



SCREEN PRINTING

BARREL

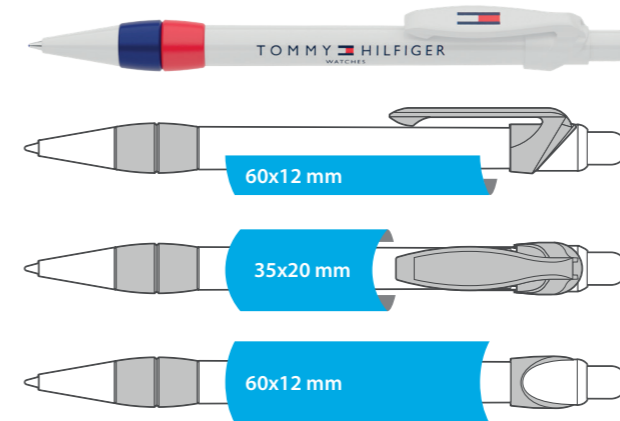

360° PRINTING

BARREL

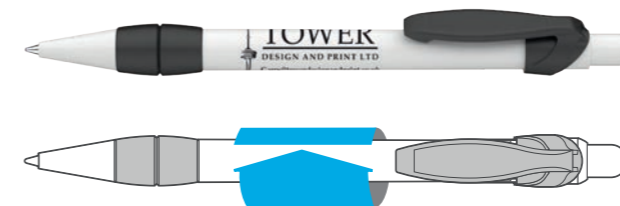

SPECIFICATIONS

Slim barrel pen with coloured clip and grip. Grip zone made of two plastic rings.

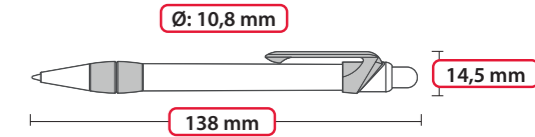

Product size: 138 mm x 14,5 mm
Diameter: 10,8 mm

Refill: X-20
ball diameter: 0,8 mm
length: 106,8 mm
writing capacity: 2500 m
available colours:

PACKAGING



- Box dimensions: W 40 cm x L 40 cm x H 27 cm
- Weight: 10 kg
- Number of pieces packed: 1000 pcs
- Unit: 200 pcs/polybag

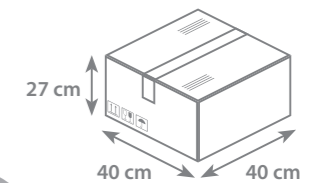

For further information go to Page 65.



BUGGY 007

COLOUR



BRANDING POSSIBILITIES

PAD PRINTING

CLIP

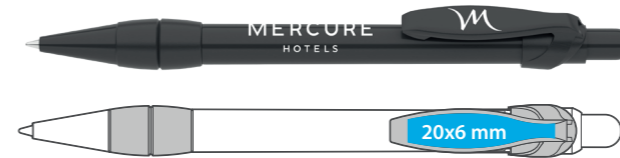

SCREEN PRINTING

BARREL

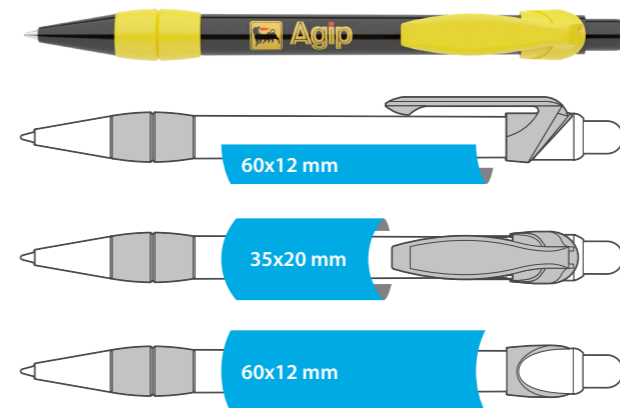

360° PRINTING

BARREL

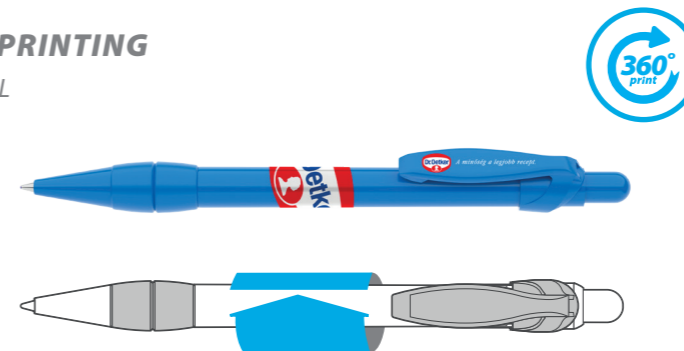

SPECIFICATIONS

Solid colour, slim barrel pen with coloured clip and grip. Grip zone made of two plastic rings.

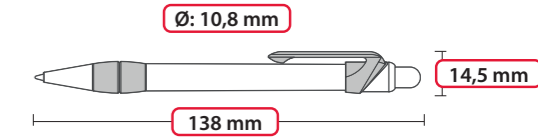

Product size: 138 mm x 14,5 mm
Diameter: 10,8 mm

Refill: X-20
ball diameter: 0,8 mm
length: 106,8 mm
writing capacity: 2500 m
available colours:

PACKAGING



- Box dimensions: W 40 cm x L 40 cm x H 27 cm
- Weight: 10 kg
- Number of pieces packed: 1000 pcs
- Unit: 200 pcs/polybag

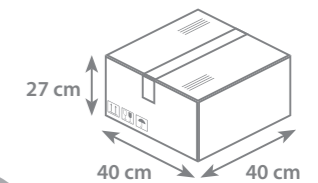

For further information go to Page 65.

SUNNY

STANDARD

Available Colours:

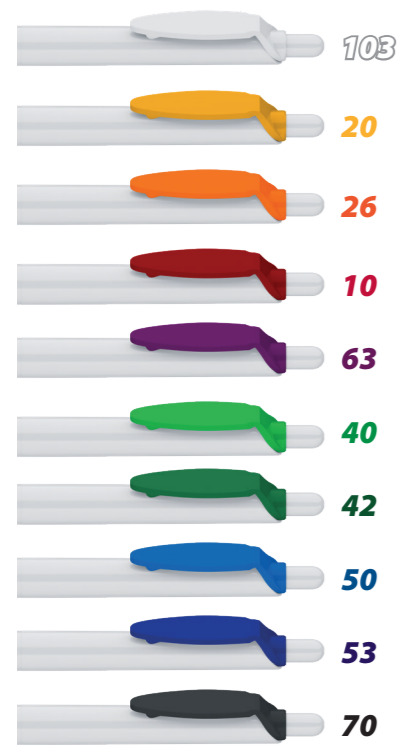

BRANDING POSSIBILITIES

PAD PRINTING

CLIP

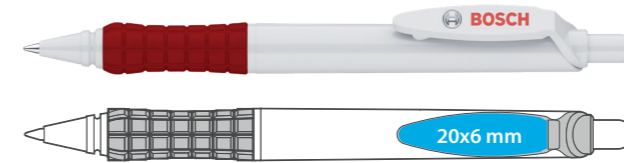

SCREEN PRINTING

BARREL

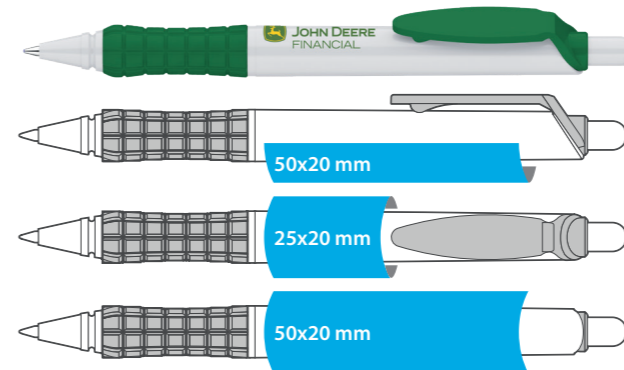

360° PRINTING

BARREL

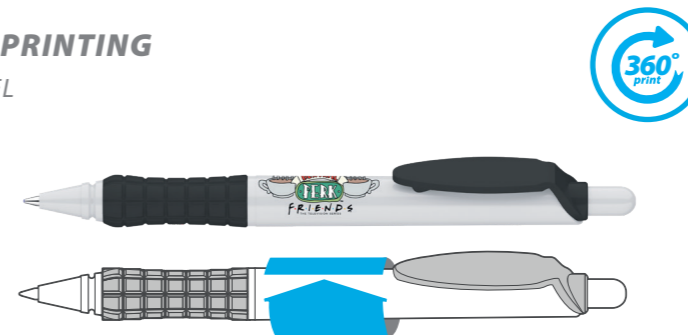

SPECIFICATIONS

Our favourite ballpen. Large print area and a molded rubber grip makes this pen comfortable to hold.

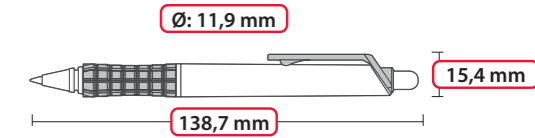

Product size: **138,7 mm x 15,4 mm**
Diameter: **11,9 mm**

Refill: **X-20**
ball diameter: **0,8 mm**
length: **106,8 mm**
writing capacity: **2500 m**
available colours:

PACKAGING



- Box dimensions: W 40 cm x L 40 cm x H 27 cm
- Weight: 11 kg
- Number of pieces packed: 1000 pcs
- Unit: 200 pcs/polybag

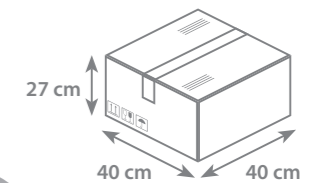

For further information go to Page 65.



SUNNY

COLOUR

Available Colours:

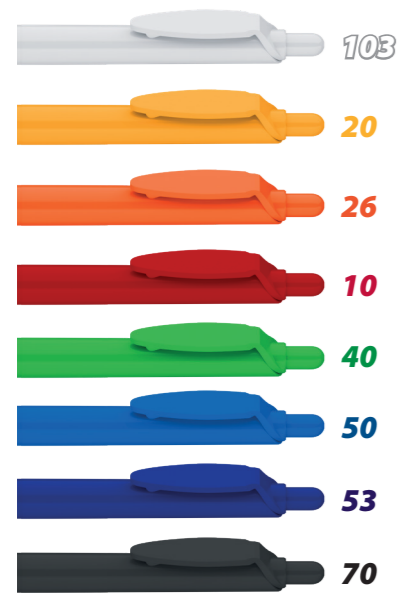

BRANDING POSSIBILITIES

PAD PRINTING

CLIP

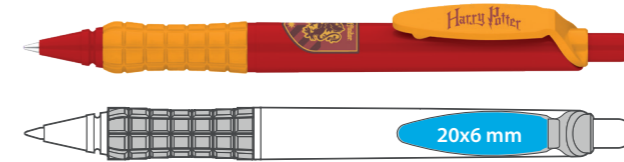

SCREEN PRINTING

BARREL

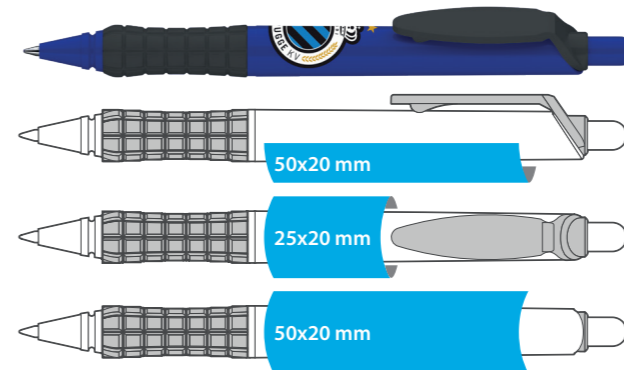

360° PRINTING

BARREL

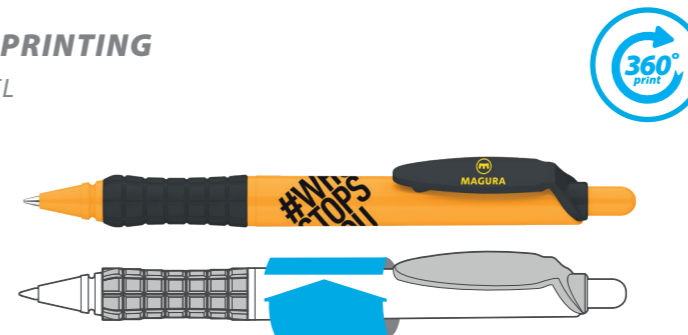

SPECIFICATIONS

Our favourite ballpen. Large print area and a molded rubber grip makes this pen comfortable to hold.

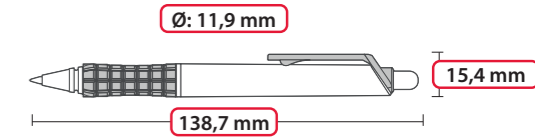

Product size: **138,7 mm x 15,4 mm**
Diameter: **11,9 mm**

Refill: **X-20**
ball diameter: **0,8 mm**
length: **106,8 mm**
writing capacity: **2500 m**
available colours:

PACKAGING



- Box dimensions: W 40 cm x L 40 cm x H 27 cm
- Weight: 11 kg
- Number of pieces packed: 1000 pcs
- Unit: 200 pcs/polybag

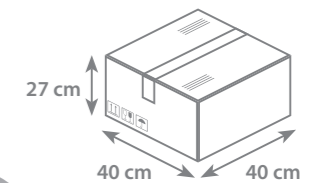

For further information go to Page 65.

X-PEN

Available Colours:

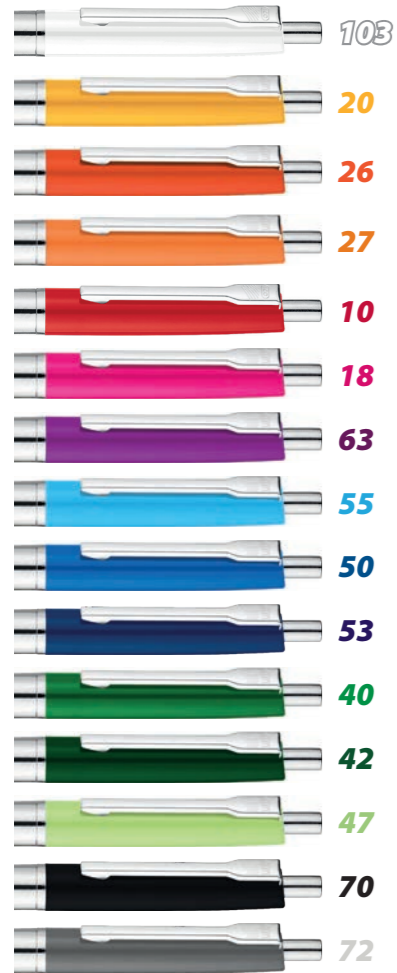

BRANDING POSSIBILITIES

SCREEN PRINTING

BARREL



SPECIFICATIONS

Metal barrel with plastic top available in different colours.

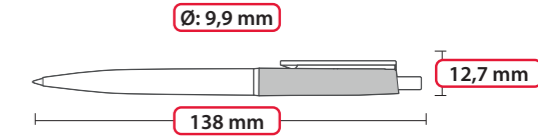

Product size: **138 mm x 12,7 mm**
Diameter: **9,9 mm**

Refill: **Silver**
ball diameter: **0,8 mm**
length: **98 mm**
writing capacity: **5000 m**
available colours:

PACKAGING



- Box dimensions:
W 40 cm x L 40 cm x H 27 cm
- Weight: 14 kg
- Number of pieces packed: 1000 pcs
- Unit: 200 pcs/polybag

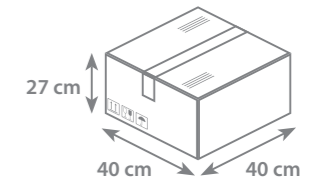

ORION

Available Colours:



BRANDING POSSIBILITIES

SCREEN PRINTING

BARREL



360° PRINTING

BARREL

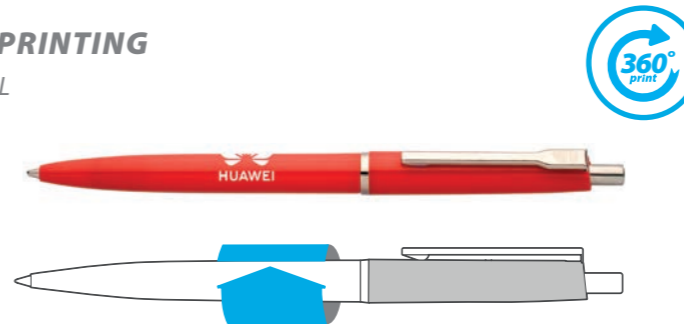

SPECIFICATIONS

Another classic, much like the X-pen. With plastic barrel and elegant silver trim.

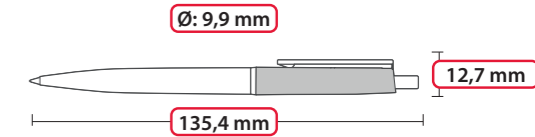

Product size: **135,4 mm x 12,7 mm**
Diameter: **9,9 mm**

Refill: **X-20**
ball diameter: **0,8 mm**
length: **106,8 mm**
writing capacity: **2500 m**
available colours:

PACKAGING



- Box dimensions: W 40 cm x L 40 cm x H 27 cm
- Weight: 9 kg
- Number of pieces packed: 1000 pcs
- Unit: 200 pcs/polybag

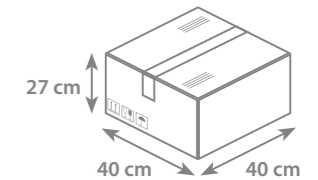

SILVER

COLOUR



Available Colours:

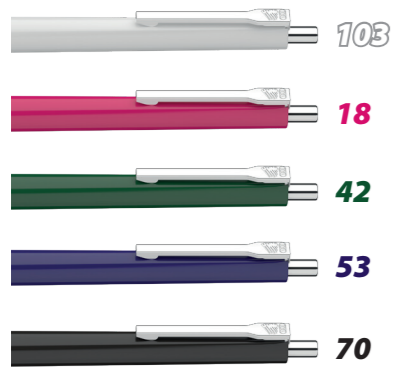

BRANDING POSSIBILITIES

SCREEN PRINTING

BARREL



SPECIFICATIONS

Lightweight executive pen with classy silver trim.

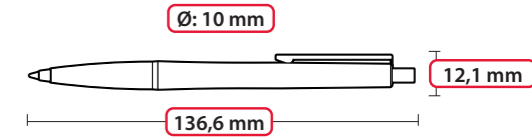

Product size: **136,6 mm x 12,1 mm**
Diameter: **10 mm**

Refill: **X-20**
ball diameter: **0,8 mm**
length: **106,8 mm**
writing capacity: **2500 m**
available colours:

PACKAGING



- Box dimensions:
W 34 cm x L 34 cm x H 18 cm
- Weight: 8 kg
- Number of pieces packed: 1000 pcs
- Unit: 200 pcs/polybag

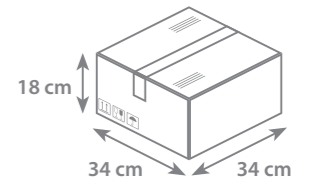

SILVER

TRANSLUCENT



Available Colours:

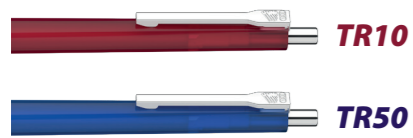

BRANDING POSSIBILITIES

SCREEN PRINTING

BARREL



SPECIFICATIONS

Lightweight executive pen with frosted, translucent barrel and classy silver trim.

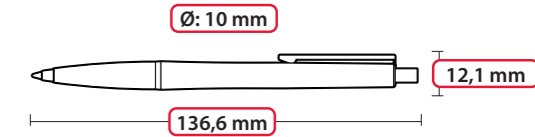

Product size: **136,6 mm x 12,1 mm**
Diameter: **10 mm**

Refill: **X-20**
ball diameter: **0,8 mm**
length: **106,8 mm**
writing capacity: **2500 m**
available colours:

PACKAGING



- Box dimensions:
W 34 cm x L 34 cm x H 18 cm
- Weight: 8 kg
- Number of pieces packed: 1000 pcs
- Unit: 200 pcs/polybag

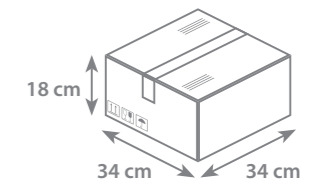

ICO 70



Available Colours:

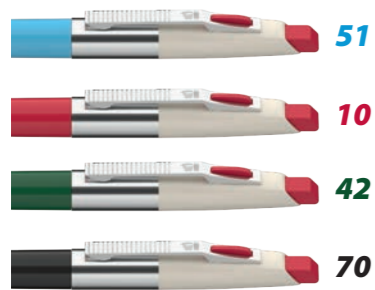

BRANDING POSSIBILITIES

SCREEN & PAD PRINTING

BARREL

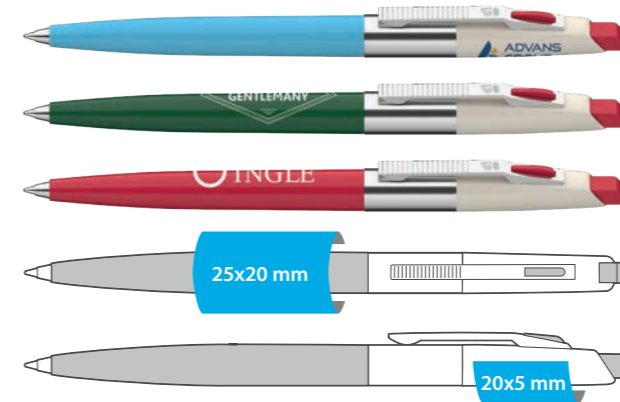

360° PRINTING

BARREL

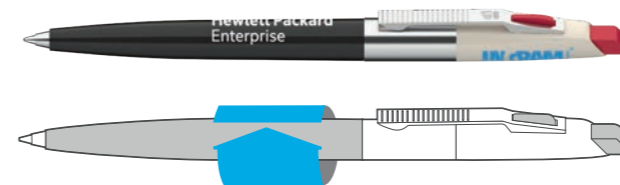

SPECIFICATIONS

Retro pen with unique mechanism. Originally produced in the 1970s. Collectors' favourite choice.

Ø: 9,4 mm

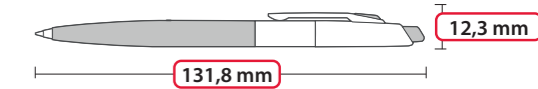

Product size: 131,8 mm x 12,3 mm
Diameter: 9,4 mm

Refill: X-20
ball diameter: 0,8 mm
length: 106,8 mm
writing capacity: 2500 m
available colours:

PACKAGING



- Box dimensions: W 40 cm x L 40 cm x H 27 cm
- Weight: 10 kg
- Number of pieces packed: 1000 pcs
- Unit: 200 pcs/polybag

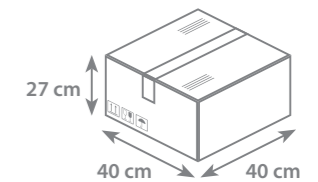

ICO 70

COLOUR

Available Colours:

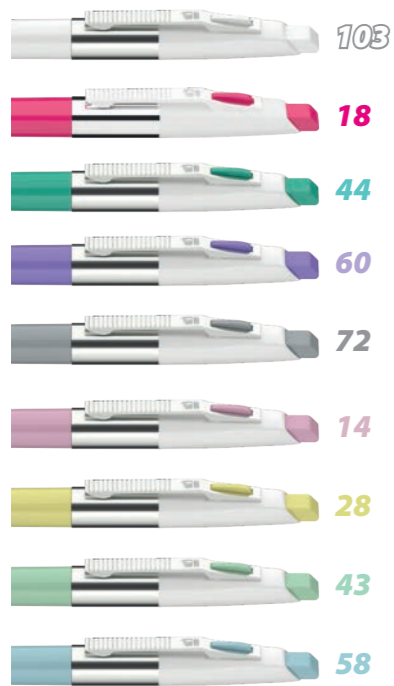

BRANDING POSSIBILITIES

SCREEN & PAD PRINTING

BARREL

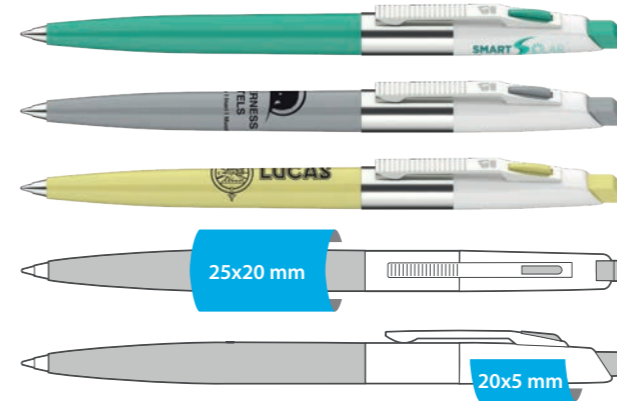

360° PRINTING

BARREL

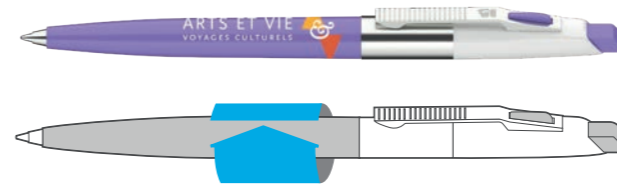

SPECIFICATIONS

Retro pen in bright colours with unique mechanism. Originally produced in the 1970s.

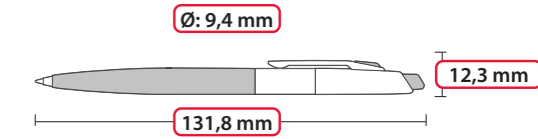

Product size: **131,8 mm x 12,3 mm**
Diameter: **9,4 mm**

Refill: **X-20**
ball diameter: **0,8 mm**
length: **106,8 mm**
writing capacity: **2500 m**
available colours:

PACKAGING



- Box dimensions: W 40 cm x L 40 cm x H 27 cm
- Weight: 10 kg
- Number of pieces packed: 1000 pcs
- Unit: 200 pcs/polybag

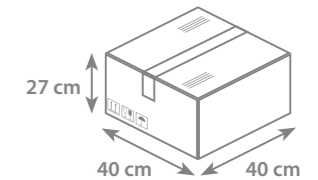

APOLLO

WHITE



Available Colours:

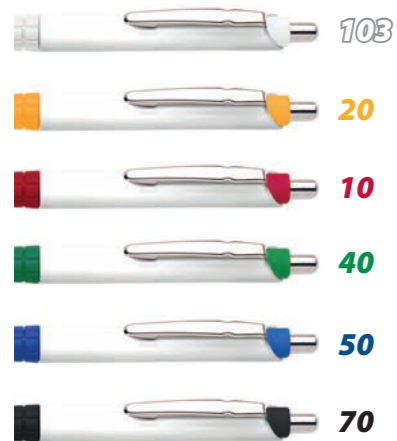

BRANDING POSSIBILITIES

SCREEN PRINTING

BARREL

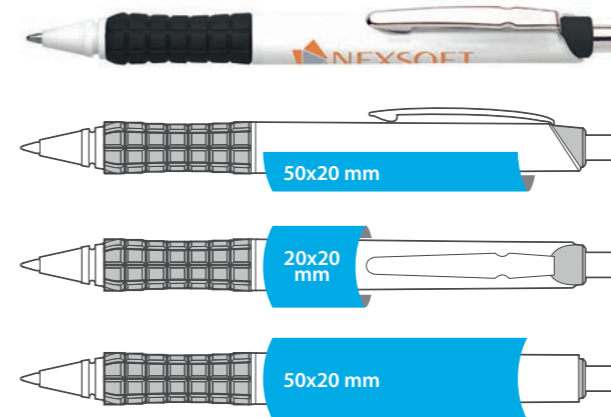

360° PRINTING

BARREL

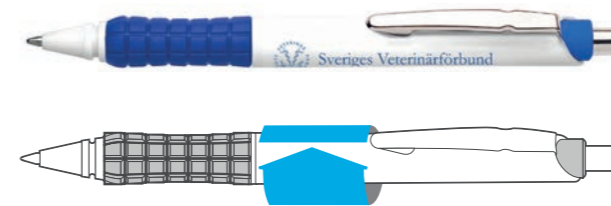

SPECIFICATIONS

A different version of Sunny with metal clip. Large print area with molded rubber grip.

Ø: 11,9 mm

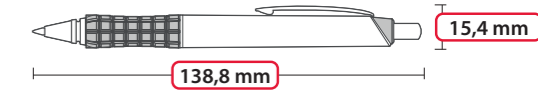

Product size: 138,8 mm x 15,4 mm

Diameter: 11,9 mm

Refill: X-20

ball diameter: 0,8 mm

length: 106,8 mm

writing capacity: 2500 m

available colours:

PACKAGING

13 kg

- Box dimensions: W 40 cm x L 40 cm x H 27 cm
- Weight: 13 kg
- Number of pieces packed: 1000 pcs
- Unit: 200 pcs/polybag

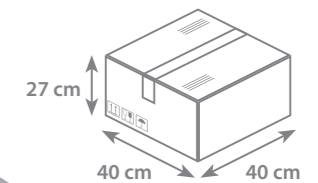

For further information go to Page 65.



APOLLO

BLACK



Available Colours:

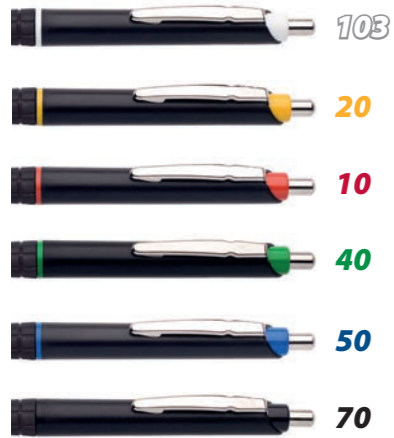

BRANDING POSSIBILITIES

SCREEN PRINTING

BARREL

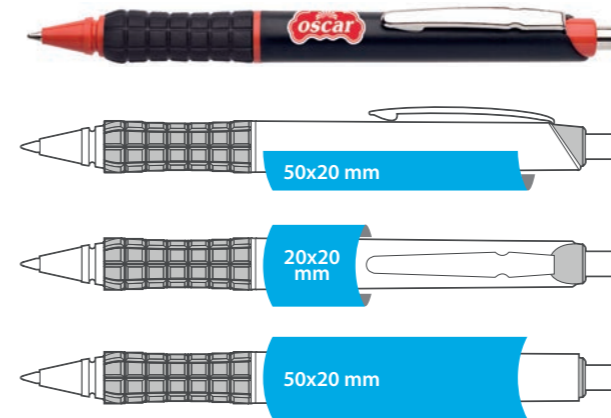

360° PRINTING

BARREL

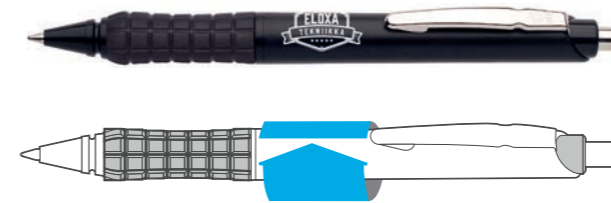

SPECIFICATIONS

A different version of Sunny with metal clip. Large print area with molded rubber grip.

Ø: 11,9 mm

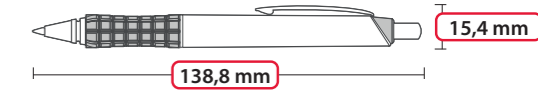

Product size: 138,8 mm x 15,4 mm
Diameter: 11,9 mm

Refill: X-20
ball diameter: 0,8 mm
length: 106,8 mm
writing capacity: 2500 m
available colours: 

PACKAGING



- Box dimensions: W 40 cm x L 40 cm x H 27 cm
- Weight: 13 kg
- Number of pieces packed: 1000 pcs
- Unit: 200 pcs/polybag

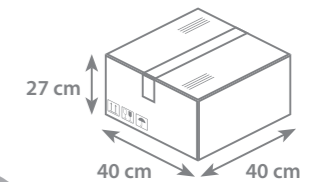

For further information go to Page 65.



POLO

Available Colours:



BRANDING POSSIBILITIES

SCREEN PRINTING

BARREL



360° PRINTING

BARREL



SPECIFICATIONS

Mechanical ballpoint pen with replaceable large capacity ink refill. Plastic grip.

Ø: 9,9 mm

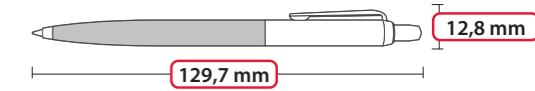

Product size: 129,7 mm x 12,8 mm
Diameter: 9,9 mm

Refill: **Plastic Jumbo**
ball diameter: 0,8 mm
length: 98 mm
writing capacity: 5000 m
available colours:

PACKAGING



- Box dimensions: W 40 cm x L 40 cm x H 27 cm
- Weight: 12 kg
- Number of pieces packed: 1000 pcs
- Unit: 200 pcs/polybag

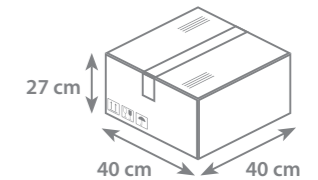



Style your pen according to your own preferences

Combine any of the colours on this page - this way you can create a unique pen by selecting a different colour for each part.



Apoello



Sunny



Buggy 007



Alfa 007



Olimpia 007



Star



Starlet



Nova



Eco Pen

ICO Colours

Pantone Colours

○	103	white
●	24	panitone 107 C
●	20	panitone 1235 C
●	26	panitone 166 C
●	10	panitone 200 C
●	63	panitone 255 C
●	60	panitone 2665 C
●	18	panitone 214 C
●	47	panitone 366 C
●	40	panitone 355 C
●	42	panitone 357 C
●	55	panitone 298 C
●	50	panitone 2945 C
●	53	panitone 2755 C
●	72	panitone 429 C
●	70	black

TRANSLUCENT

○	TR00	transparent
●	TR10	red
●	TR50	blue
●	TR70	black

Please contact our colleagues for further information and minimum order quantities.

FOCUS

NEON

Available Colours:



BRANDING POSSIBILITIES

PAD PRINTING

BARREL

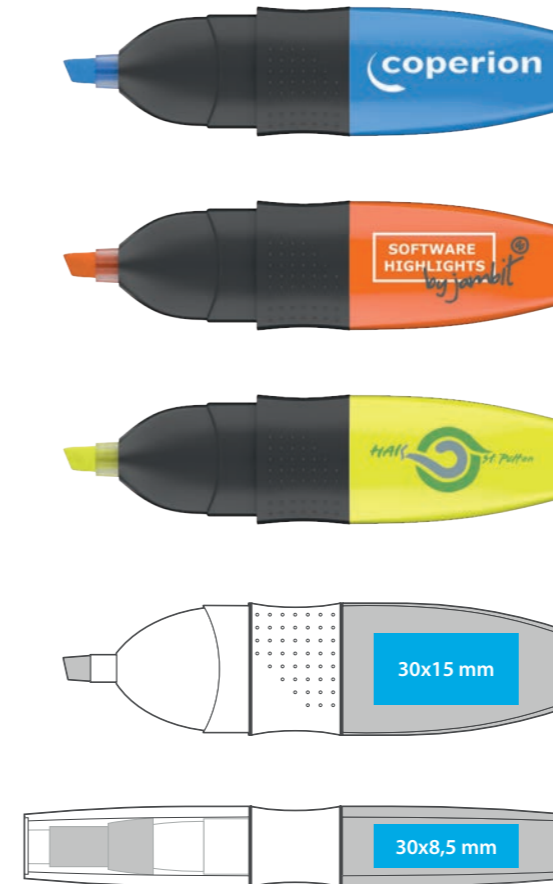

SPECIFICATIONS

Highlighter with coloured barrel and transparent black cap, chisel nib filled with water based fluorescent ink.

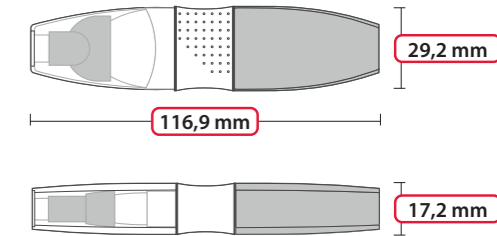

Product size: **116,9 mm x 29,2 mm**
Height: **17,2 mm**

Nib: **chisel**
Line thickness: **1-4 mm**

PACKAGING



- Box dimensions: W 40 cm x L 40 cm x H 27 cm
- Weight: 11 kg
- Number of pieces packed: 500 pcs

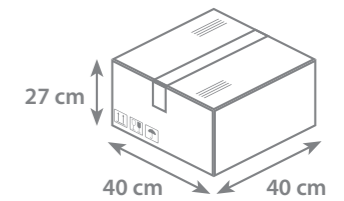

FOCUS

PASTEL

Available Colours:



BRANDING POSSIBILITIES

PAD PRINTING

BARREL

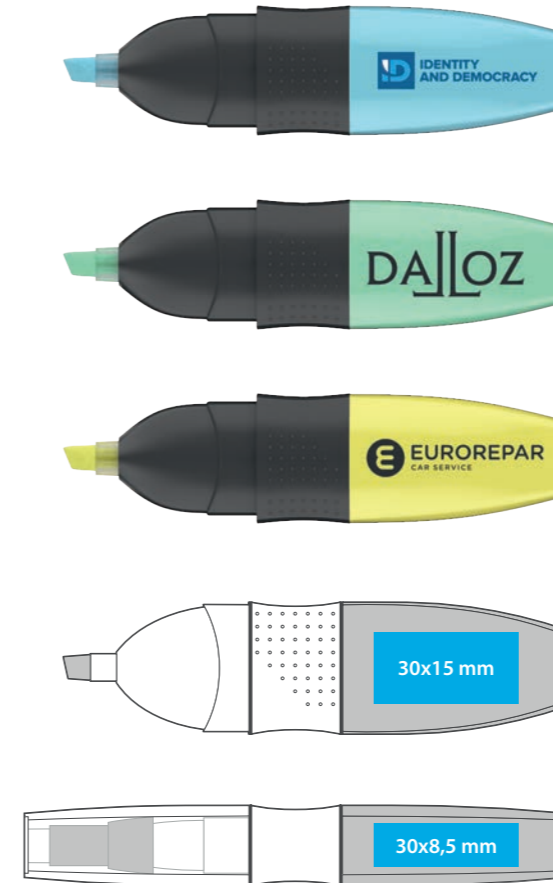

SPECIFICATIONS

Highlighter with pastel coloured barrel and transparent black cap, chisel nip filled with water based pastel ink.

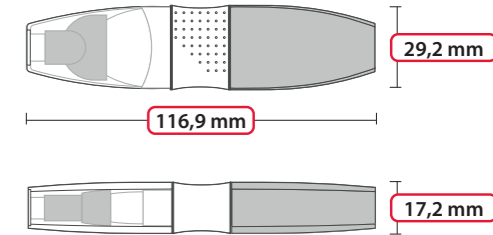

Product size: 116,9 mm x 29,2 mm

Height: 17,2 mm

Nib: **chisel**

Line thickness: 1-4 mm

PACKAGING



- Box dimensions: W 40 cm x L 40 cm x H 27 cm
- Weight: 11 kg
- Number of pieces packed: 500 pcs

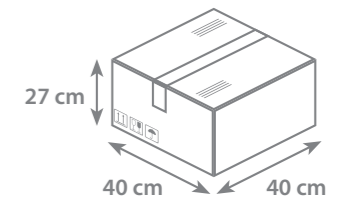

VIDEOTIP

STANDARD

WITH VENTILATED CAP



Available Colours:



BRANDING POSSIBILITIES

SCREEN PRINTING

BARREL



360° PRINTING

BARREL



SPECIFICATIONS

Highlighter assembled from coloured plastic parts and chisel nib filled with water based fluorescent ink.

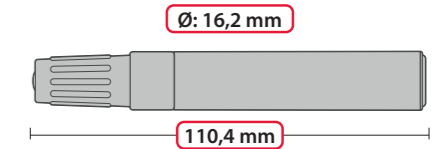

Product length: 110,4 mm

Diameter: 16,2 mm

Nib: **chisel**

Line thickness: 1-4 mm

PACKAGING



- Box dimensions:
 - (a) W 40 cm x L 40 cm x H 27 cm
 - (b) W 34 cm x L 34 cm x H 18 cm
- Weight: 7 kg
- Number of pieces packed: 500 pcs

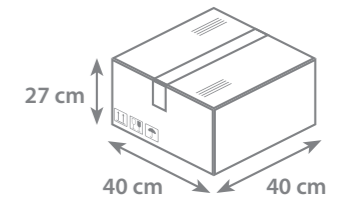

VIDEOTIP

PASTEL

WITH VENTILATED CAP



Available Colours:



BRANDING POSSIBILITIES

SCREEN PRINTING

BARREL



360° PRINTING

BARREL



SPECIFICATIONS

Highlighter assembled from pastel coloured plastic parts and chisel nib filled with water based pastel ink.

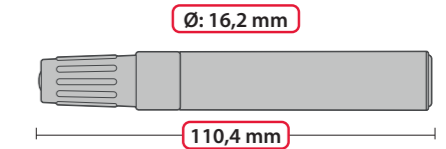

Product length: 110,4 mm

Diameter: 16,2 mm

Nib: **chisel**

Line thickness: 1-4 mm

PACKAGING



- Box dimensions:
 - (a) W 40 cm x L 40 cm x H 27 cm
 - (b) W 34 cm x L 34 cm x H 18 cm
- Weight: 7 kg
- Number of pieces packed: 500 pcs

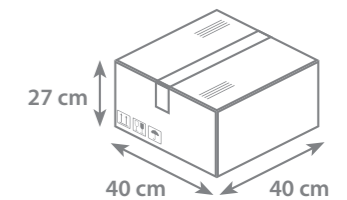

VIDEOTIP XXL

WITH VENTILATED CAP

Available Colours:



BRANDING POSSIBILITIES

SCREEN PRINTING

BARREL



360° PRINTING

BARREL

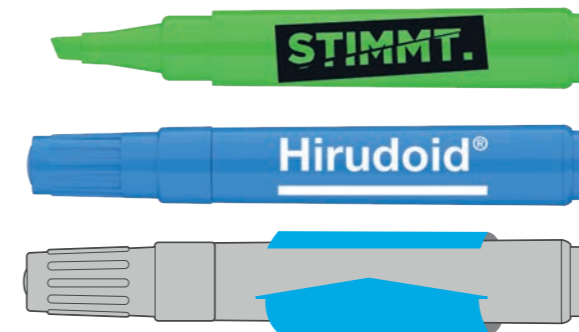

SPECIFICATIONS

Highlighter assembled from coloured plastic parts and chisel nib filled with water based fluorescent ink.

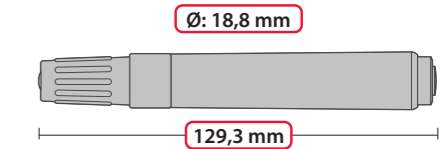

Product length: 129,3 mm

Diameter: 18,8 mm

Nib: **chisel**

Line thickness: 1-4 mm

PACKAGING



- Box dimensions: W 40 cm x L 40 cm x H 27 cm
- Weight: 9 kg
- Number of pieces packed: 500 pcs

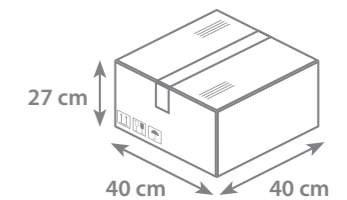

VIDEOTIP SLIM

NEON

WITH VENTILATED CAP

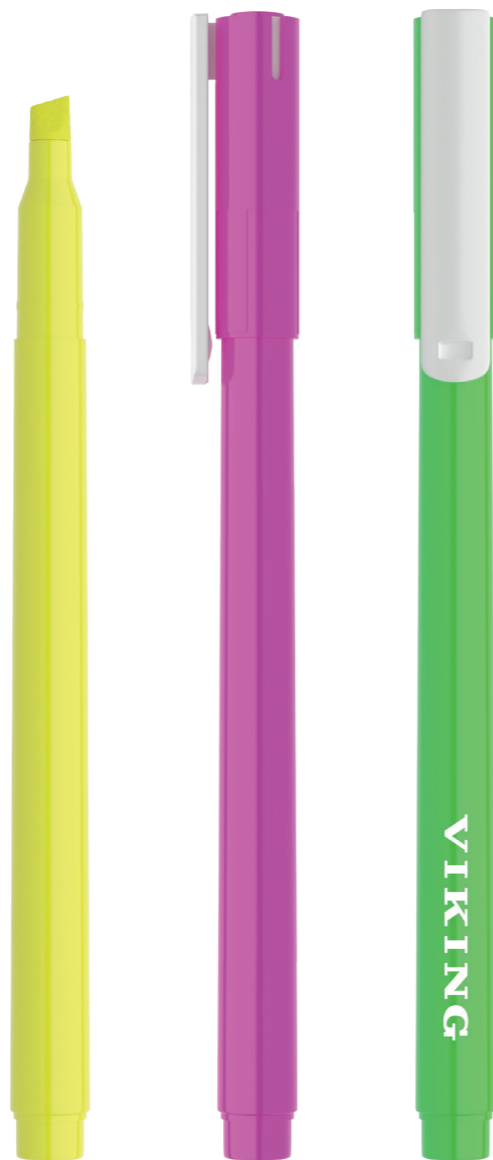

Available Colours:



neon yellow

neon pink

neon orange

neon green

BRANDING POSSIBILITIES

PAD PRINTING

CLIPS

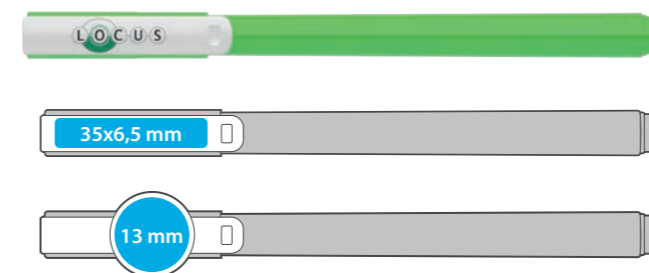

SCREEN PRINTING

BARREL



360° PRINTING

BARREL

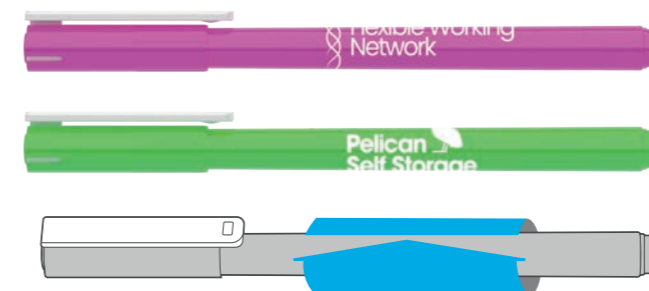

SPECIFICATIONS

Highlighter assembled from coloured plastic parts and chisel nib filled with water based fluorescent ink.

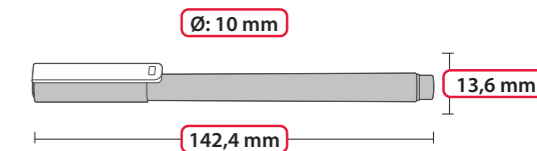

Product size: 142,4 mm x 13,6 mm
Diameter: 10 mm

Nib: **chisel**
Line thickness: 1-3 mm

PACKAGING



- Box dimensions:
W 32 cm x L 16 cm x H 21 cm
- Weight: 8 kg
- Number of pieces packed: 500 pcs

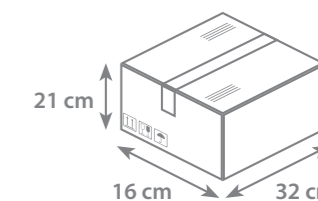

VIDEOTIP SLIM

PASTEL

WITH VENTILATED CAP

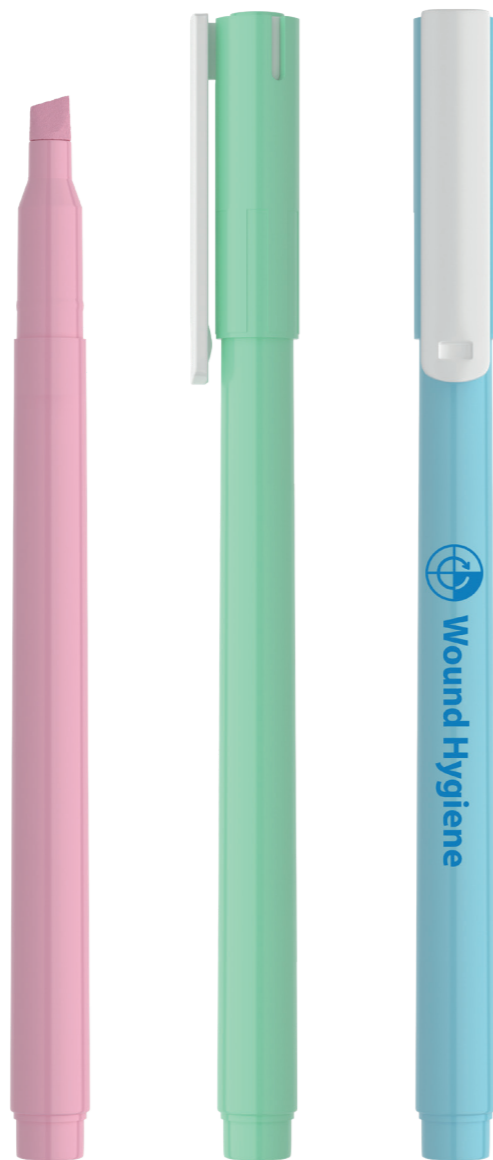

Available Colours:

 pastel yellow

 pastel pink

 pastel blue

 pastel green

BRANDING POSSIBILITIES

PAD PRINTING

CLIPS



SCREEN PRINTING

BARREL

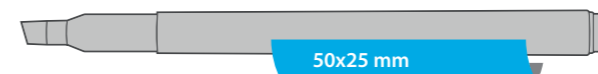

360° PRINTING

BARREL



SPECIFICATIONS

Highlighter assembled from pastel coloured plastic parts and chisel nib filled with water based pastel ink.

Ø: 10 mm



142,4 mm

Product size: 142,4 mm x 13,6 mm

Diameter: 10 mm

Nib: chisel

Line thickness: 1-3 mm

PACKAGING



- Box dimensions: W 32 cm x L 16 cm x H 21 cm
- Weight: 8 kg
- Number of pieces packed: 500 pcs

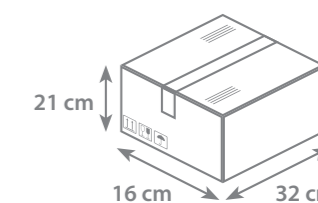

WHITEBOARD MARKER M

WITH VENTILATED CAP



Available Colours:



BRANDING POSSIBILITIES

SCREEN PRINTING

BARREL

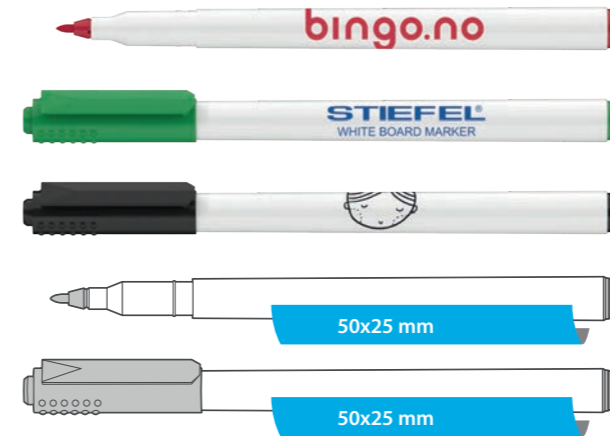

360° PRINTING

BARREL

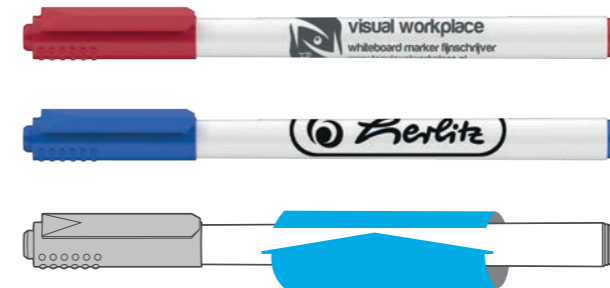

SPECIFICATIONS

Fibre pen filled with dry-wipe ink, suitable for writing on whiteboards.

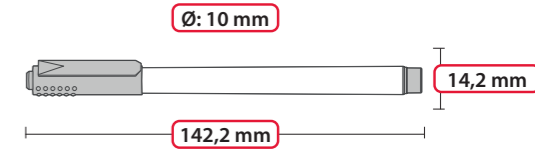

Product size: 142,2 mm x 14,2 mm

Diameter: 10 mm

Nib: **bullet**

Line thickness: 1-1,5 mm

PACKAGING



- Box dimensions: W 34 cm x L 34 cm x H 18 cm
- Weight: 7 kg
- Number of pieces packed: 1000 pcs

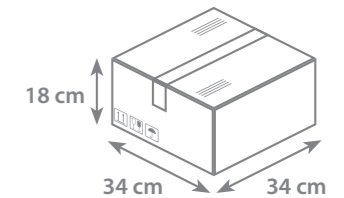

WHITEBOARD MARKER

WITH VENTILATED CAP

CAP-OFF
3 DAYS

Available Colours:

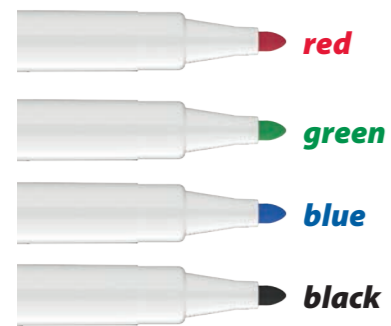

BRANDING POSSIBILITIES

SCREEN PRINTING

BARREL



360° PRINTING

BARREL



SPECIFICATIONS

Marker for writing or drawing on whiteboards. The writing is dry-wipeable.

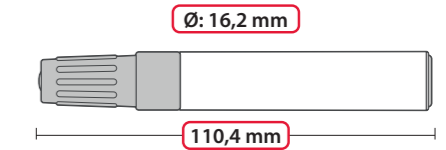

Product length: 110,4 mm

Diameter: 16,2 mm

Nib: **bullet**

Line thickness: 1-3 mm

PACKAGING



- Box dimensions: W 40 cm x L 40 cm x H 27 cm
- Weight: 15 kg
- Number of pieces packed: 1000 pcs

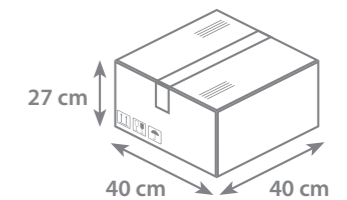

WHITEBOARD MARKER XXL

WITH VENTILATED CAP

CAP-OFF
3 DAYS



Available Colours:

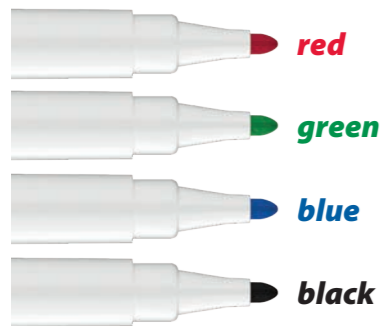

BRANDING POSSIBILITIES

SCREEN PRINTING

BARREL

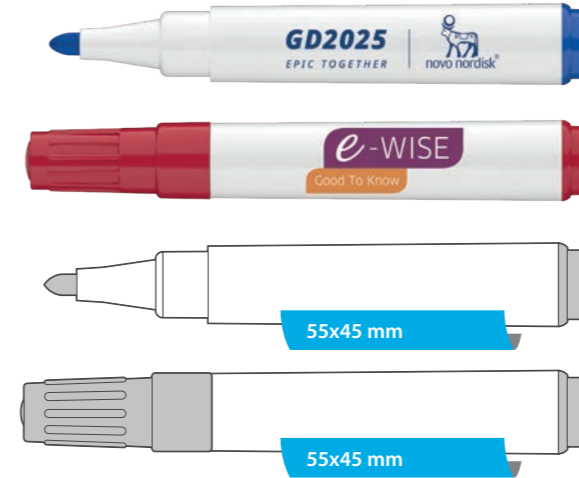

360° PRINTING

BARREL



SPECIFICATIONS

Marker for writing or drawing on whiteboards. The writing is dry-wipeable.

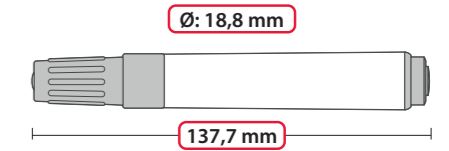

Product length: 137,7 mm

Diameter: 18,8 mm

Nib: **bullet**

Line thickness: 1-3 mm

PACKAGING

11 kg

- Box dimensions: W 40 cm x L 40 cm x H 27 cm
- Weight: 11 kg
- Number of pieces packed: 500 pcs

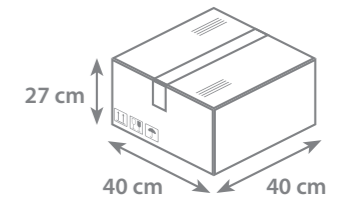

WHITEBOARD MARKER

MULTIFUNCTIONAL

WITH ERASER AND MAGNET AND VENTILATED CAP

CAP-OFF
3 DAYS



Available Colours:

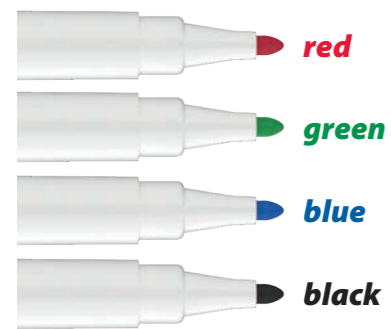

BRANDING POSSIBILITIES

SCREEN PRINTING

BARREL

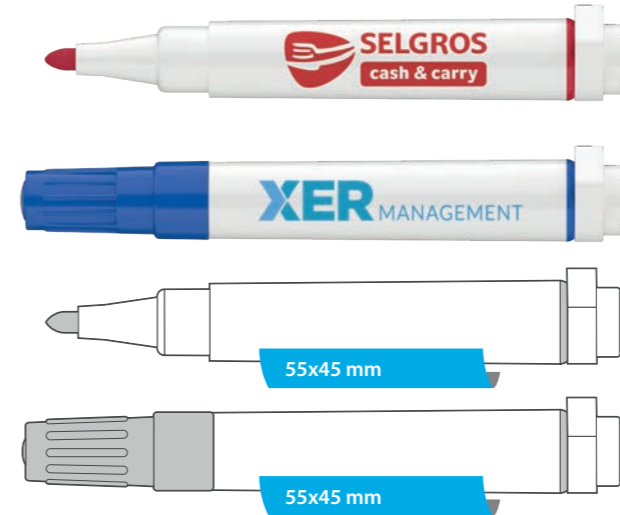

360° PRINTING

BARREL

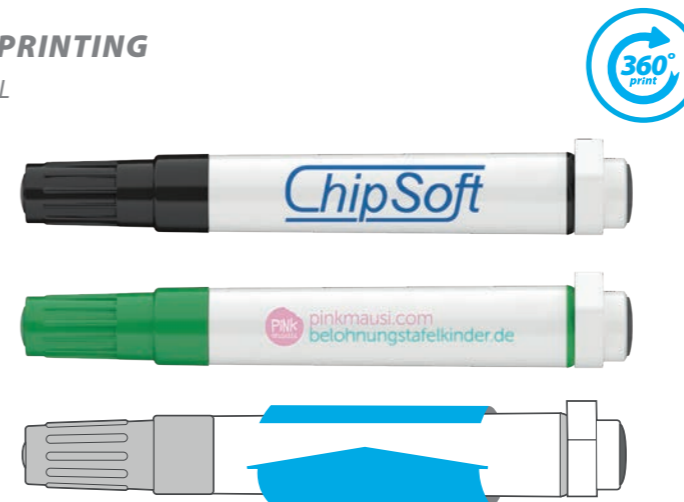

SPECIFICATIONS

Marker for writing or drawing on whiteboards. The writing is dry-wipeable.

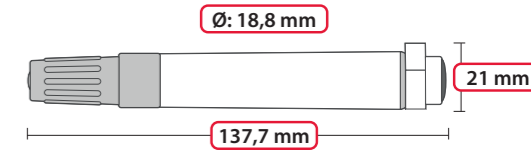

Instrument size: 137,7 mm x 21 mm
Diameter: 18,8 mm

Nib: **bullet**
Line thickness: 1-3 mm

PACKAGING



- Box dimensions: W 40 cm x L 40 cm x H 27 cm
- Weight: 10 kg
- Number of pieces packed: 500 pcs

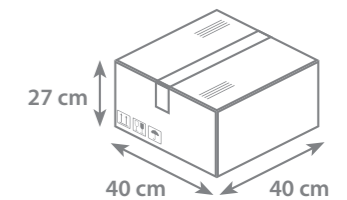

PERMANENT F

OHP MARKER

WITH VENTILATED CAP

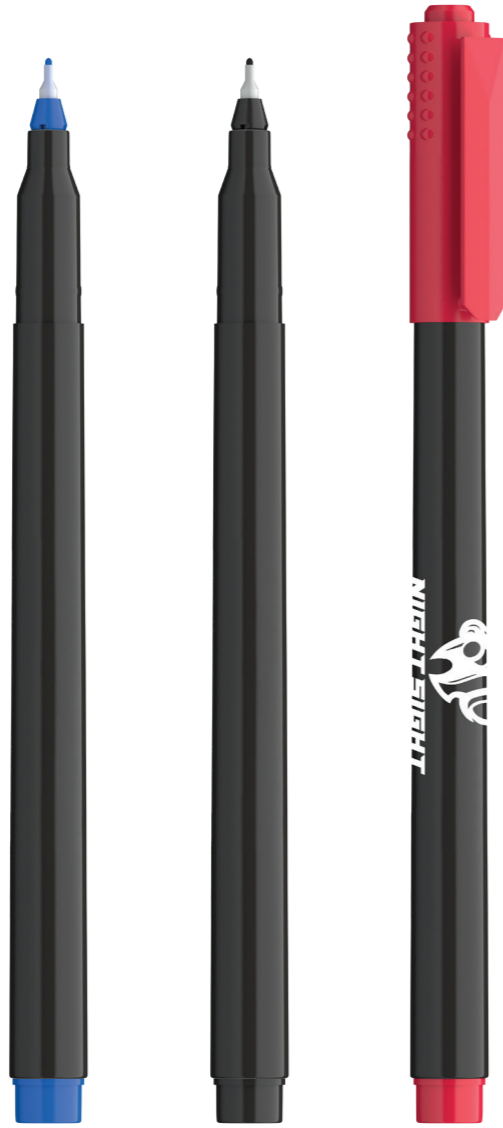

Available Colours:



BRANDING POSSIBILITIES

SCREEN PRINTING

BARREL



SPECIFICATIONS

Permanent fine liner assembled with black barrel and coloured cap. Filled with alcohol-based permanent ink.

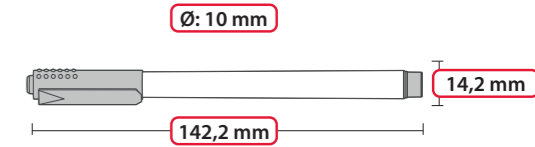

Instrument size: **142,2 mm x 14,2 mm**
Diameter: **10 mm**

Line thickness: **0,5 mm**

PACKAGING



- Box dimensions:
W 34 cm x L 34 cm x H 18 cm
- Weight: 8 kg
- Number of pieces packed: 1000 pcs

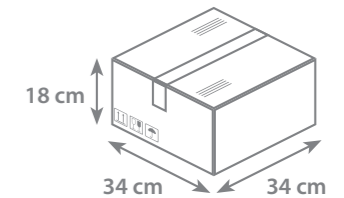

PERMANENT M

OHP MARKER

WITH VENTILATED CAP

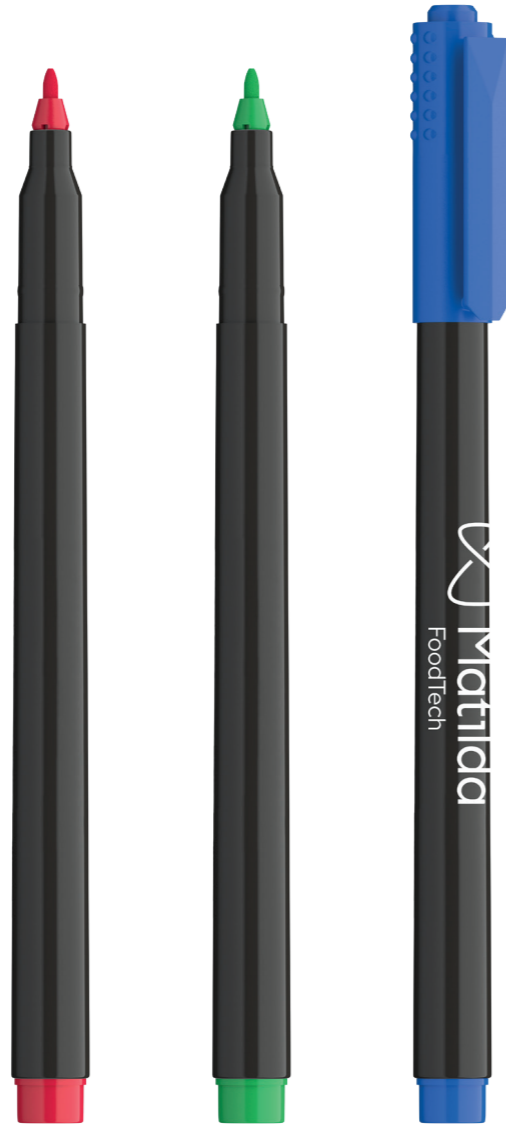

Available Colours:



red

green

blue

black

BRANDING POSSIBILITIES

SCREEN PRINTING

BARREL



SPECIFICATIONS

Permanent fibre pen assembled with black barrel and coloured cap. Filled with alcohol-based permanent ink.

Ø: 10 mm

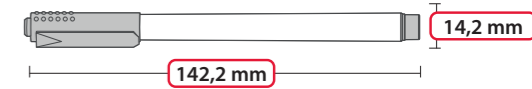

Product size: 142,2 mm x 14,2 mm

Diameter: 10 mm

Nib: **medium**

Line thickness: 1-1,5 mm

PACKAGING



- Box dimensions: W 34 cm x L 34 cm x H 18 cm
- Weight: 8 kg
- Number of pieces packed: 1000 pcs

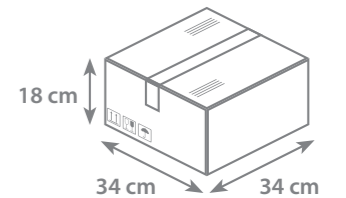

PERMANENT MARKER XXL

WITH VENTILATED CAP



Available Colours:

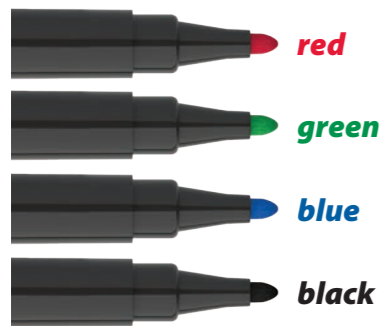

BRANDING POSSIBILITIES

SCREEN PRINTING

BARREL

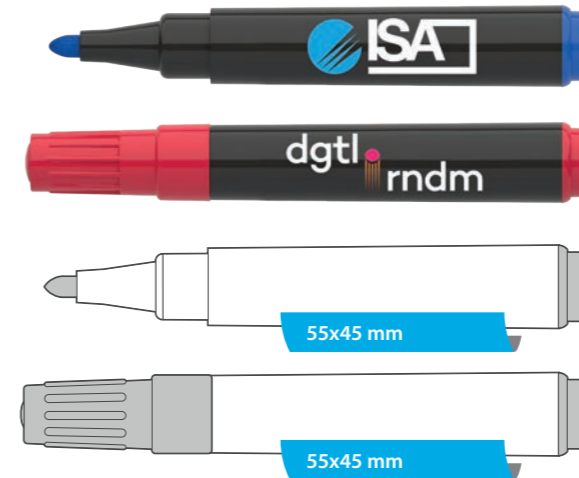

360° PRINTING

BARREL



SPECIFICATIONS

Marker for writing or drawing on whiteboards. The writing is dry-wipeable.

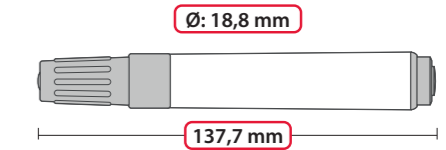

Product length: **137,7 mm**

Diameter: **18,8 mm**

Nib: **bullet**

Line thickness: **1-3 mm**

PACKAGING

11
kg

- Box dimensions: W 40 cm x L 40 cm x H 27 cm
- Weight: 11 kg
- Number of pieces packed: 500 pcs

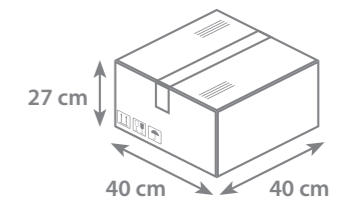

ICO 300

FIBRE PEN

WITH VENTILATED CAP



Available Colours:

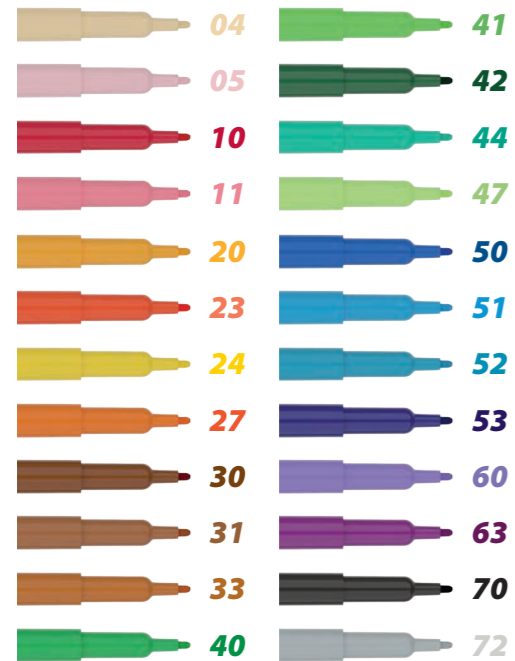

BRANDING POSSIBILITIES

SCREEN PRINTING

BARREL

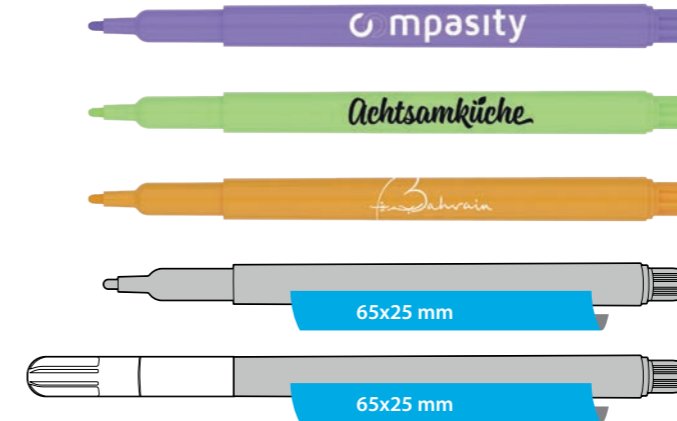

360° PRINTING

BARREL



SPECIFICATIONS

Fibre pen filled with water-based ink with ventilated cap. Suitable for children.

Ø: 10,3 mm



162 mm

Instrument size: 162 mm

Diameter: 10,3 mm

Line thickness: 1-1,5 mm

PACKAGING



- Box dimensions: W 34 cm x L 34 cm x H 18 cm
- Weight: 8 kg
- Number of pieces packed: 1000 pcs

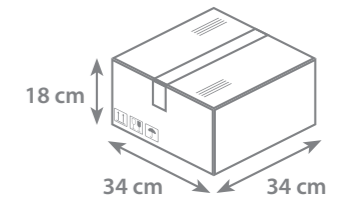

BRUSH PEN

FIBRE PEN

WITH VENTILATED CAP

Available Colours:

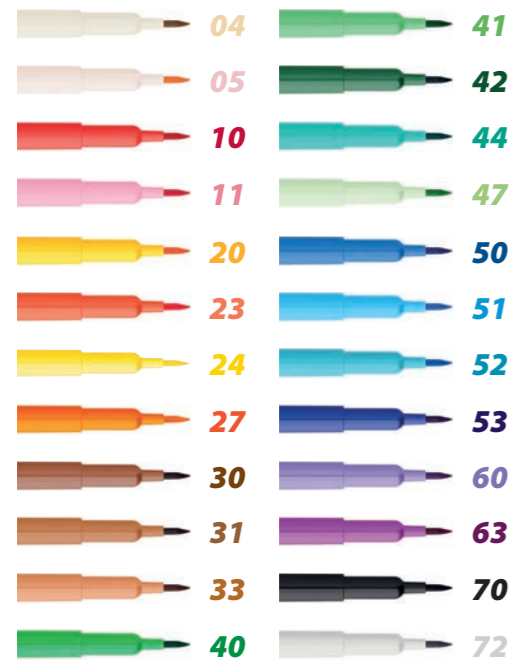

BRANDING POSSIBILITIES

SCREEN PRINTING

BARREL

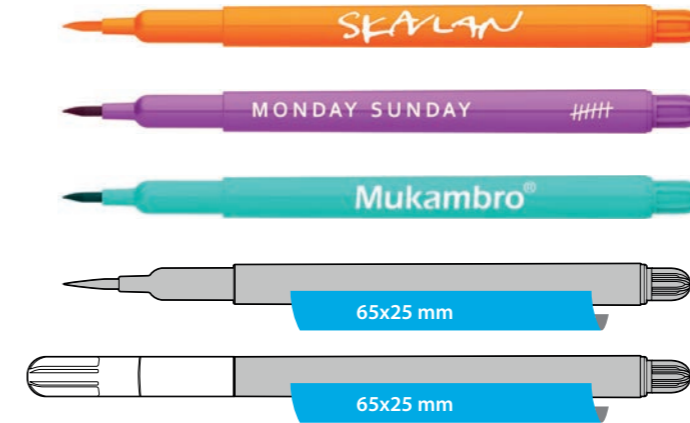

360° PRINTING

BARREL

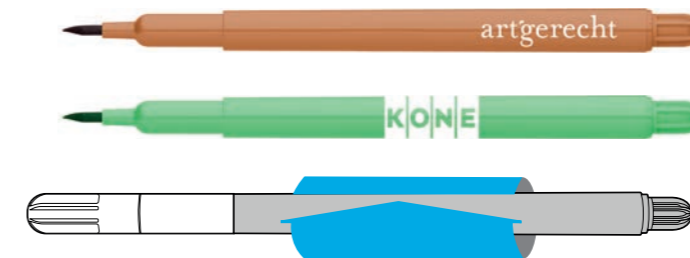

SPECIFICATIONS

Fibre pen filled with water-based ink, suitable for calligraphic writing or for colouring. With special type of brush-like nib.

Ø: 10,3 mm

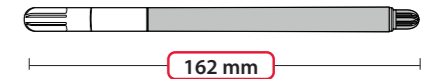

Instrument size: 162 mm

Diameter: 10,3 mm

Nib: brush-like, flexible

Line thickness: 1-3 mm

PACKAGING



- Box dimensions: W 34 cm x L 34 cm x H 18 cm
- Weight: 8 kg
- Number of pieces packed: 1000 pcs

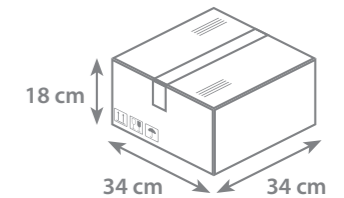

T-SHIRT MARKER

WITH VENTILATED CAP

Available Colours:

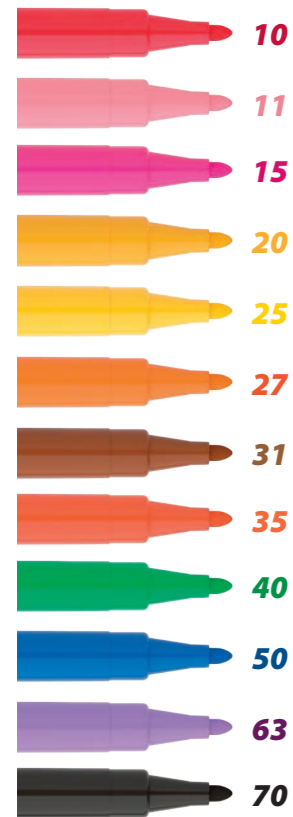

BRANDING POSSIBILITIES

SCREEN PRINTING

BARREL

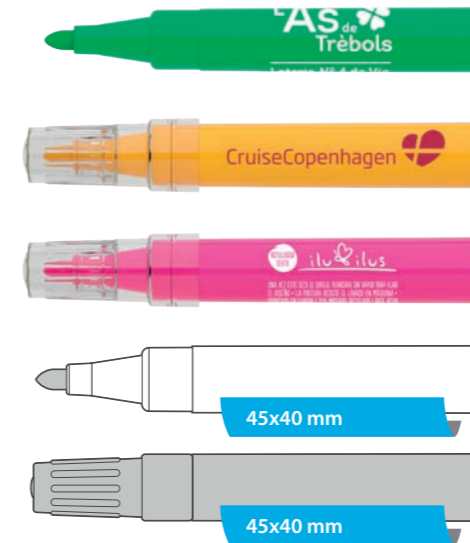

360° PRINTING

BARREL



SPECIFICATIONS

Small size textile marking pen with water-based ink.

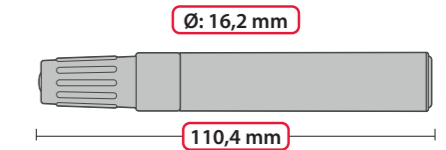

Instrument size: **110,4 mm**

Diameter: **16,2 mm**

Nib: **bullet**

Line thickness: **1-3 mm**

PACKAGING



- Box dimensions: W 40 cm x L 40 cm x H 27 cm
- Weight: 14 kg
- Number of pieces packed: 1000 pcs

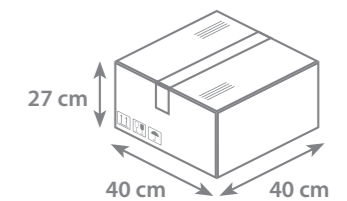

T-SHIRT MARKER XXL

WITH VENTILATED CAP

Available Colours:

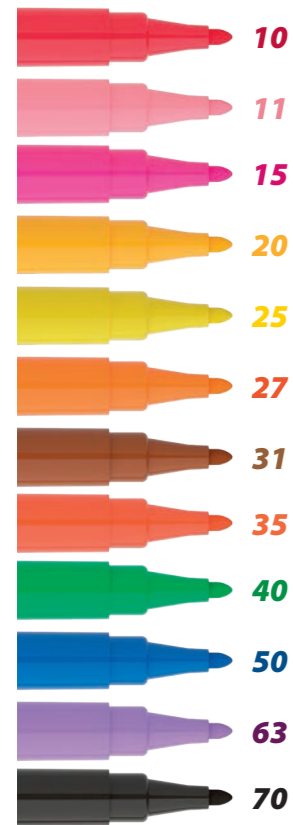

BRANDING POSSIBILITIES

SCREEN PRINTING

BARREL

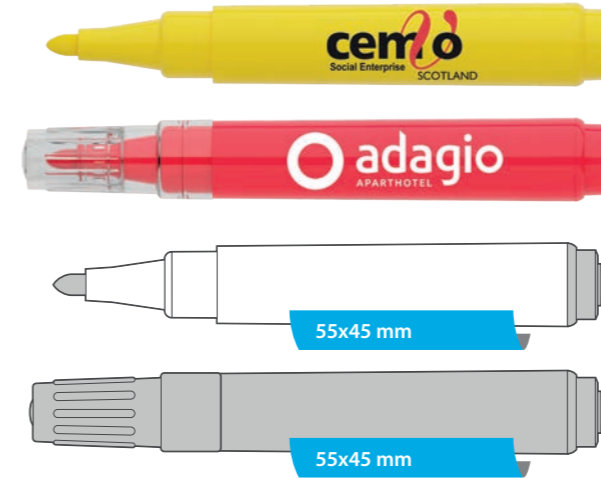

360° PRINTING

BARREL

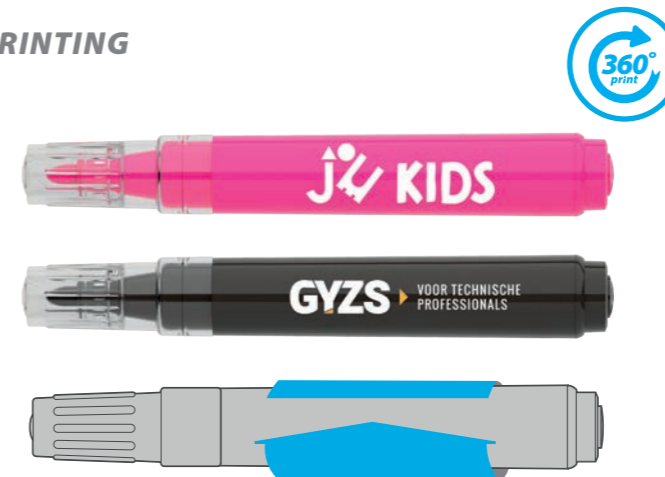

SPECIFICATIONS

Textile marking pen with water-based ink.

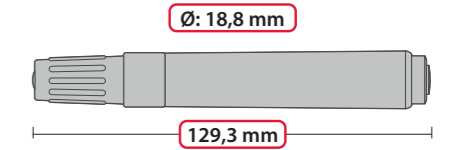

Instrument size: 129,3 mm

Diameter: 18,8 mm

Nib: **bullet**

Line thickness: 1-3 mm

PACKAGING



- Box dimensions: W 40 cm x L 40 cm x H 27 cm
- Weight: 9 kg
- Number of pieces packed: 500 pcs

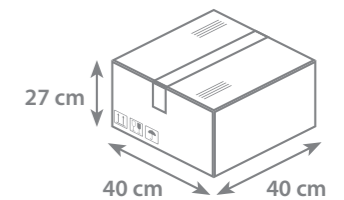

ICO T-PEN

COUNTER PEN



Wire Colours:

- 103
- 24
- 70

Available Colours:



103

10

40

53

70

BRANDING POSSIBILITIES

PAD & SCREEN PRINTING

BASE/BARREL

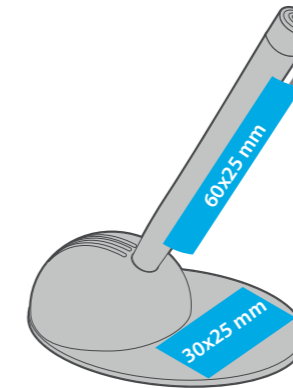

SPECIFICATIONS

White solid barrel, non-slip adhesive strip at the base.

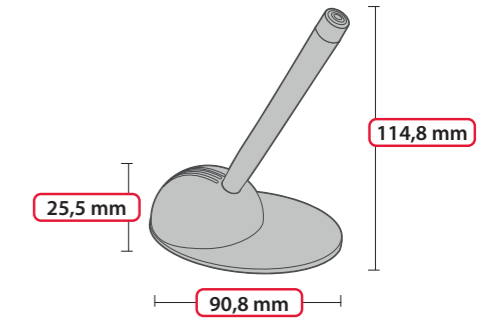

Total height: **114,8 mm**
Base size: **25,5 mm x 90,8 mm**

Refill: **X-20**
ball diameter: **0,8 mm**
length: **106,8 mm**
writing capacity: **2500 m**
available colours:

PACKAGING



- Box dimensions: W 50 cm x L 50 cm x H 27 cm
- Weight: 7 kg
- Number of pieces packed: 200 pcs

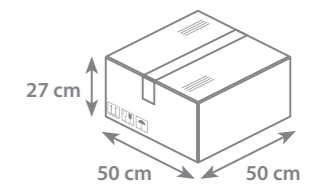

ICO LUX

COUNTER PEN



Wire Colours:

- 103
- 24
- 70

Available Colours:



103 - 103

103 - 53

103 - 70

tr. black

tr. blue

BRANDING POSSIBILITIES

PAD & SCREEN PRINTING

BASE/BARREL

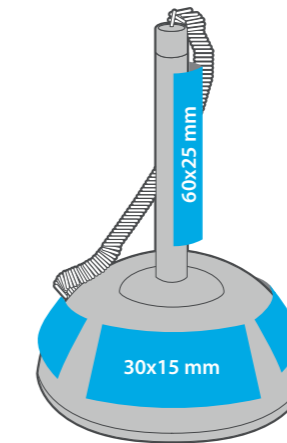

SPECIFICATIONS

White solid barrel, non-slip disks at the base.

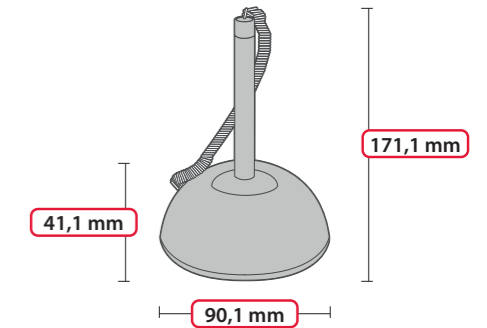

Total height: 171,1 mm
Base size: 90,1 mm x 41,1 mm

Refill: X-20
ball diameter: 0,8 mm
length: 106,8 mm
writing capacity: 2500 m
available colours:

PACKAGING



- Box dimensions: W 50 cm x L 50 cm x H 27 cm
- Weight: 17 kg
- Number of pieces packed: 100 pcs

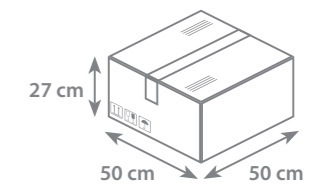

ICO LUX

PEN POT

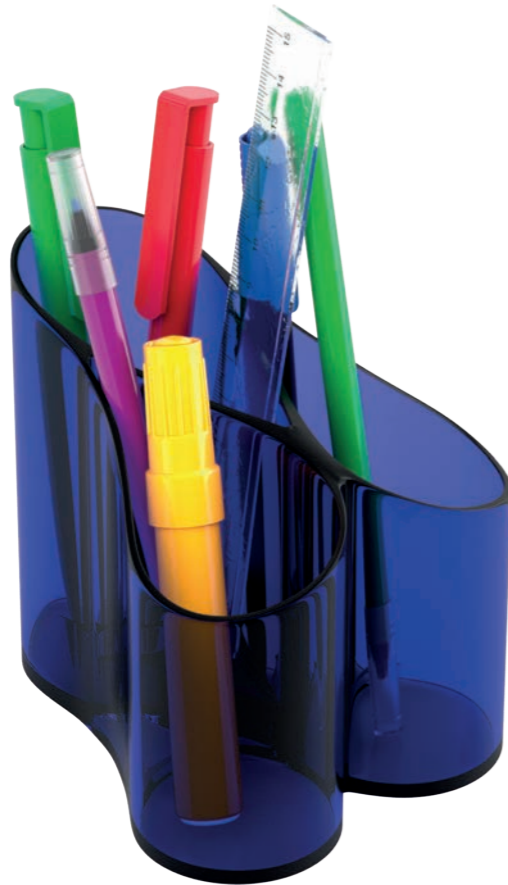

Available Colours:



18

27

47

55

TR70

TR50

BRANDING POSSIBILITIES

PAD PRINTING

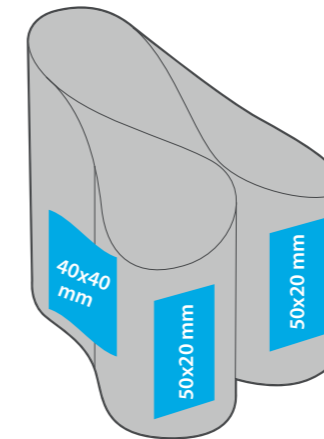

SPECIFICATIONS

Pen holder designed by ICO with three sections for pens.

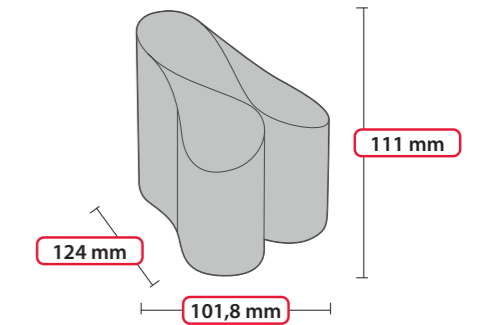

Size: 101,8 mm x 111 mm
Depth: 124 mm

PACKAGING



- Box dimensions: W 59 x L 39 x H 25
- Weight: 6 kg
- Number of pieces packed: 40 pcs

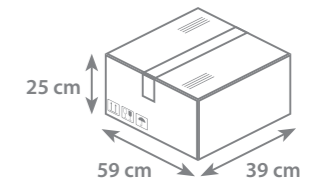

ICO QUADRAT

PEN POT



Available Colours:



18



27



47



55



TR70



TR50

BRANDING POSSIBILITIES

PAD PRINTING

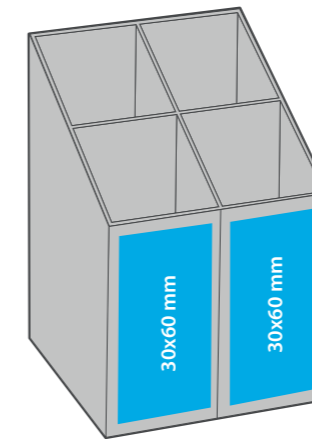

SPECIFICATIONS

Square-shaped pen holder with four sections for pens.

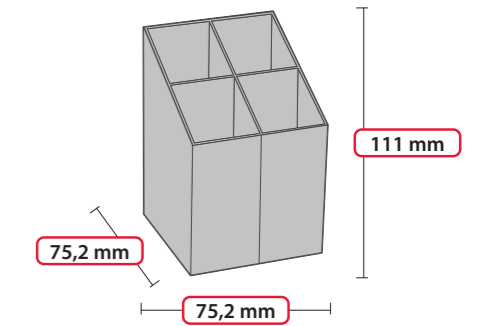

Size: 75,2 mm x 111 mm
Depth: 75,2 mm

PACKAGING



- Box dimensions:
W 55 cm x L 44 cm x H 38 cm
- Weight: 12 kg
- Number of pieces packed: 96 pcs

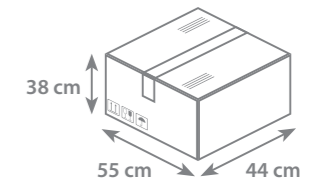

ICO RING

PEN POT



Available Colours:



18

27

47

55

70

BRANDING POSSIBILITIES

OFFSET PRINT

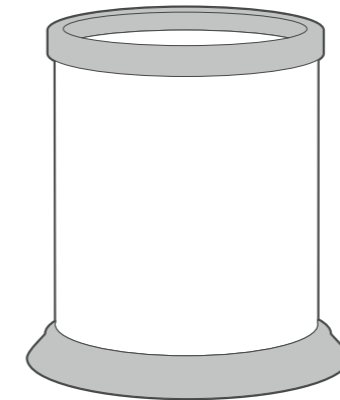

255x90 mm

SPECIFICATIONS

Round-shaped pen holder with plastic ring at top and bottom.

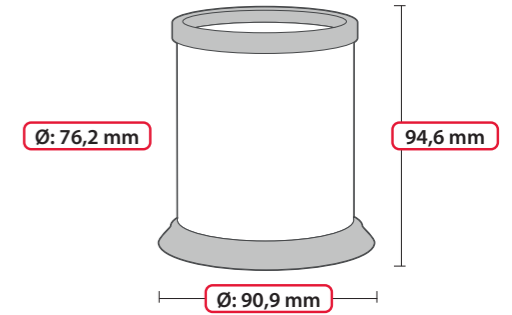

Total height: **94,6 mm**
Middle diameter: **76,2 mm**
Bottom ring diameter: **90,9 mm**

PACKAGING



- Box dimensions: W 50 cm x L 50 cm x H 27 cm
- Weight: 5 kg
- Number of pieces packed: 60 pcs

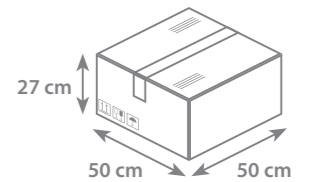

ICO SMART

PEN POT

Available Colours:



BRANDING POSSIBILITIES

PAD PRINTING



SPECIFICATIONS

Penholder with several channels for inserting pens and a V-shaped pocket for memo pads.

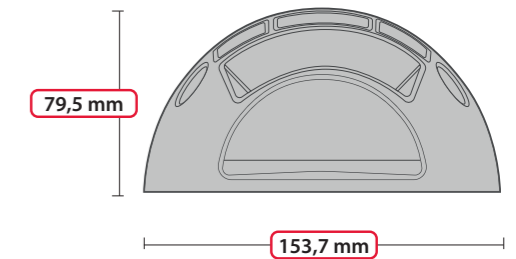

Size: 153,7 mm x 79,5 mm
Depth: 78,6 mm

PACKAGING



- Box dimensions: W 50 cm x L 50 cm x H 27 cm
- Weight: 7 kg
- Number of pieces packed: 60 pcs

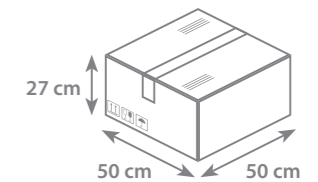

ICO SMART

TAPE DISPENSER



Available Colours:



18

27

47

55

70

BRANDING POSSIBILITIES

PAD PRINTING

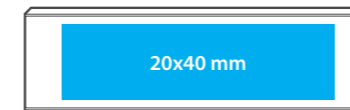
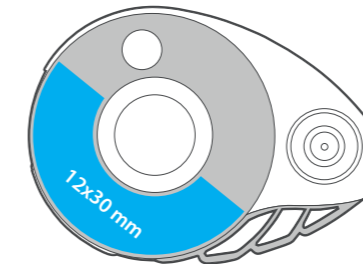

SPECIFICATIONS

Closable tape dispenser with plastic shell. 10m tape included. Blade is kept inside the shell when closed.

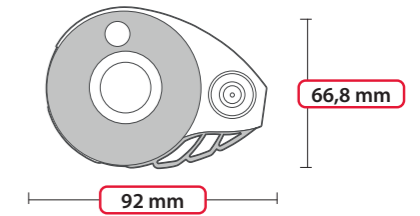

Size: 92 mm x 66,8 mm
Depth: 30 mm

PACKAGING



- Box dimensions: W 55 cm x L 44 cm x H 38 cm
- Weight: 15 kg
- Number of pieces packed: 200 pcs

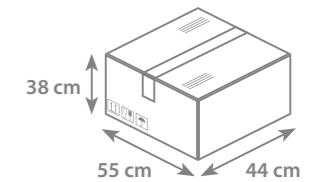

BOXER 100

STAPLER

Available Colours:



BRANDING POSSIBILITIES

PAD PRINTING

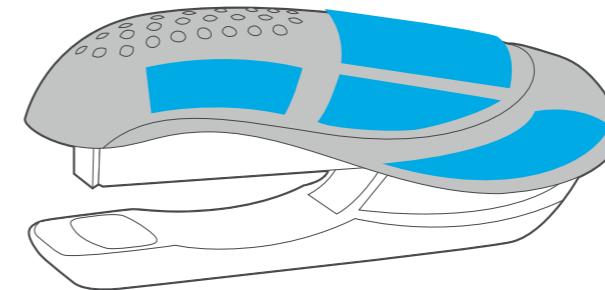

Printable surface on the top : 30x14 mm

SPECIFICATIONS

Printable No 10 stapler for 10 sheets.

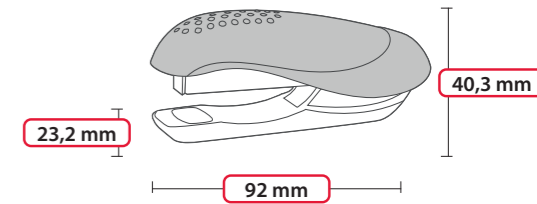

Size: 92 mm x 40,3 mm
Anvil height: 23,2 mm

PACKAGING



- Box dimensions: W 32 x L 21 x H 15,5
- Weight: 6 kg
- Number of pieces packed: 100 pcs

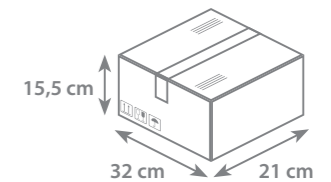

BOXER 300

STAPLER

Available Colours:



BRANDING POSSIBILITIES

PAD PRINTING

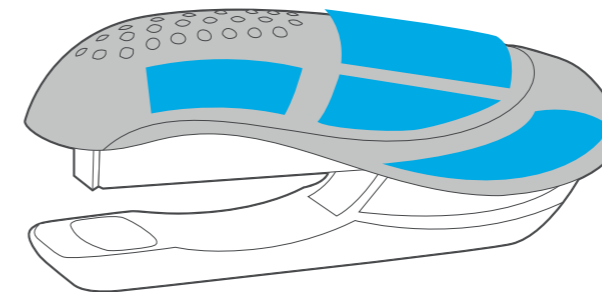

Printable surface on the top : 45x18 mm

SPECIFICATIONS

Printable 24/6 or 26/6 stapler for 20 sheets.

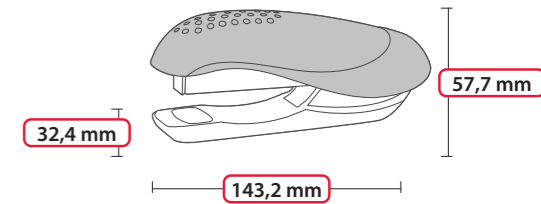

Size: 143,2 mm x 57,7 mm
Anvil height: 32,4 mm

PACKAGING



- Box dimensions: W 50 cm x L 50 cm x H 27 cm
- Weight: 16 kg
- Number of pieces packed: 120 pcs

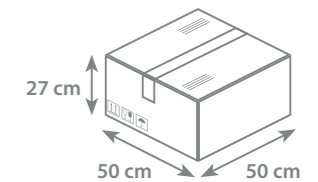

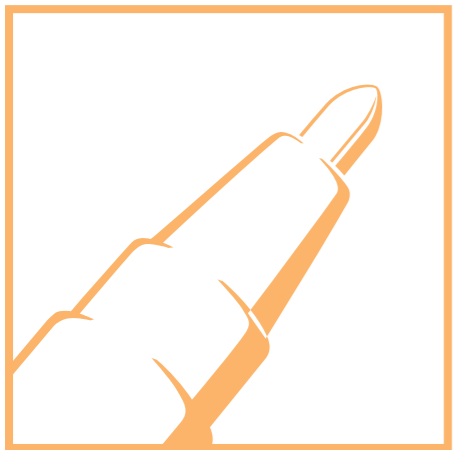
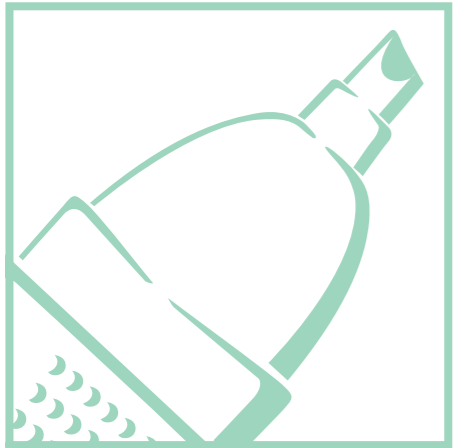
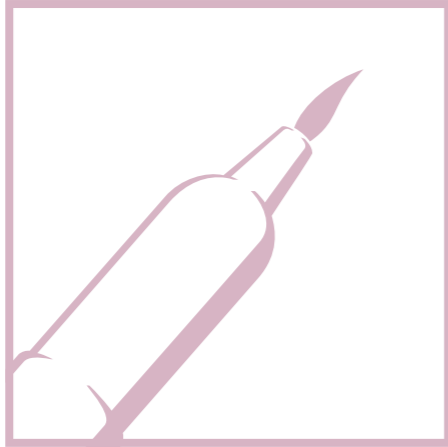
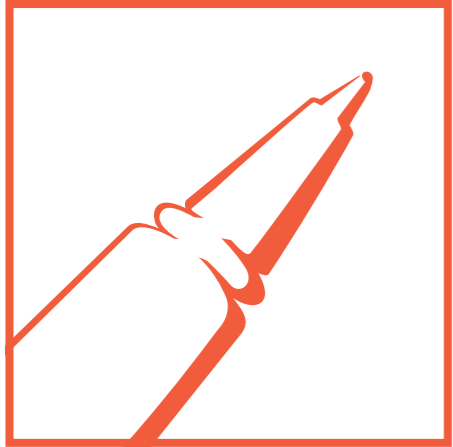

ICO INTERNATIONAL

ICO HUNGARY

H-2013 Pomáz, ICO út 5.

Telephone: +36 26 527 270, -272, -273

Fax: +36 26 527 269

E-mail: export@ico.hu

www.ico.eu

CERTIFICATIONS: **ISO 9001** AND **SEDEX**